

# FLORIM

stone

6 12 20

US

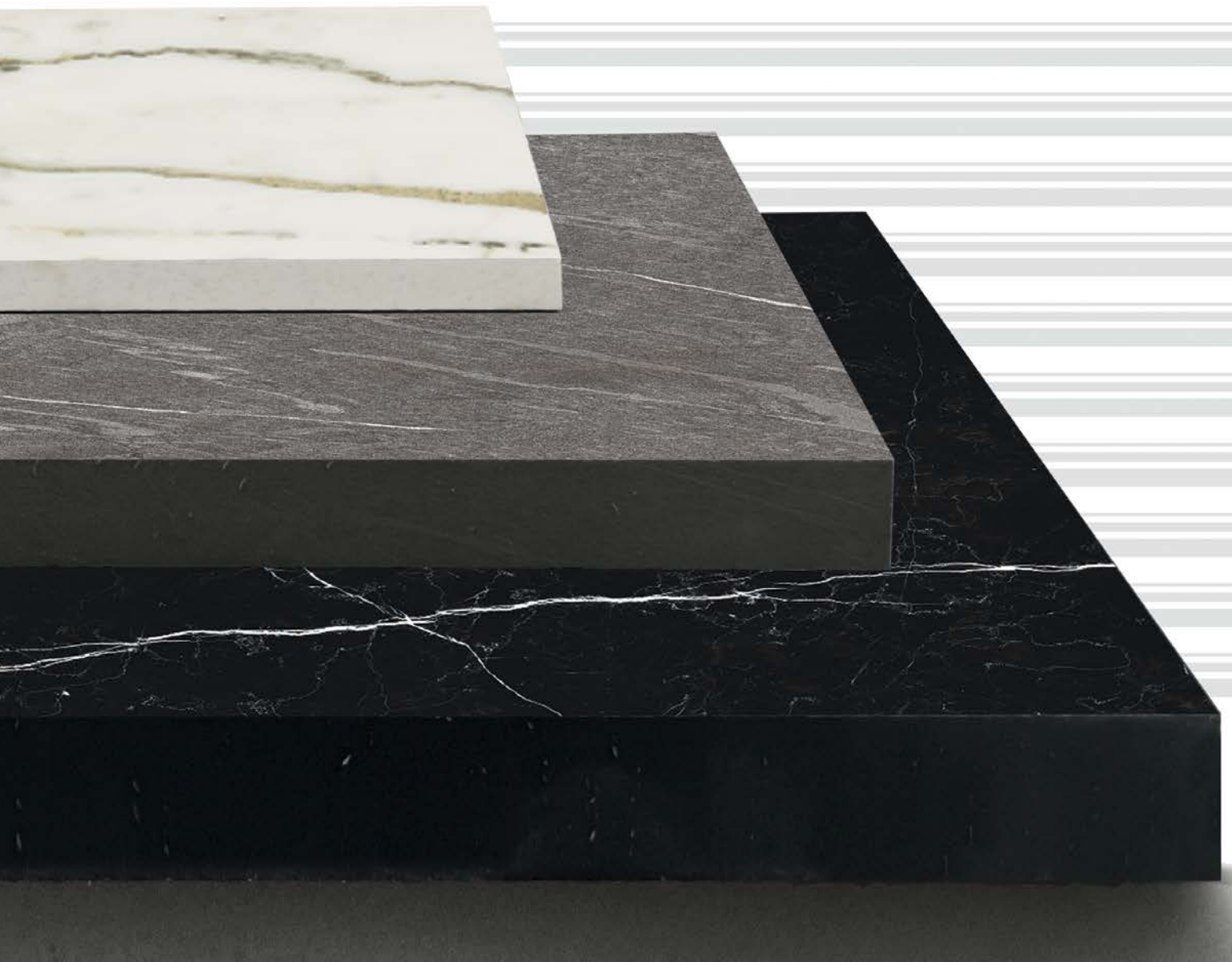

**Technical Manual**

Edited 04/2020



## INTRODUCTION

This manual provides technical and practical information about the use of **FLORIM stone** slabs: technical specification, packaging, handling, fabrication techniques, storage and maintenance. These instructions, combined with the experience and skill of the fabricator, will enable you to get the most out of the product.



# FLORIM

stone X 6.12.20

## PRODUCT

When **nature** meets **technical innovation**, the result is **FLORIM stone**, a porcelain stoneware surface developed to fulfil a wide range of applications.

A brand that seeks to combine the **functionality** and **performance** of the material while allowing maximum scope for **customisation**. **FLORIM stone** is available in a single large size (exceeding 126"x63") and a choice of **three thicknesses**: **6\*** and **12\* mm** (both reinforced with fibreglass) and **20 mm**.





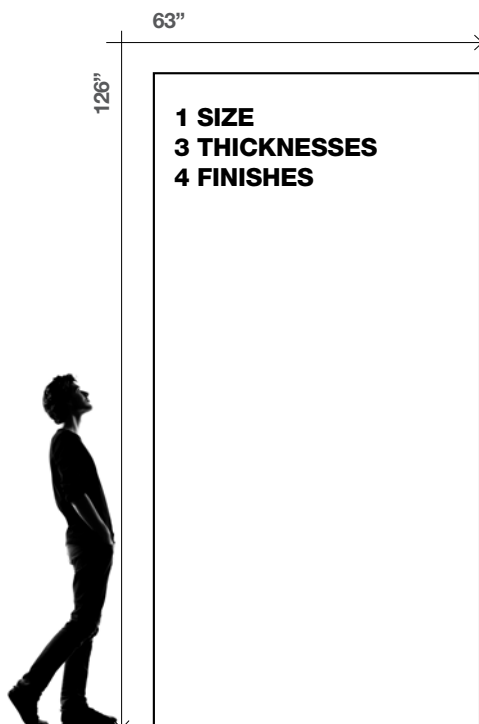

The numerous texture and colour options proposed by the brand are available in several finishes, allowing interior designers to offer creative flexibility and excellent technical and aesthetic performance. Architectural solutions for exteriors and interiors on both horizontal and vertical surfaces, such as kitchen worktops and all their accessories; the style and design of sinks, bathrooms, doors and fittings can at last be customised without compromise.

**FLORIM stone** opens the door to exceptional creative versatility in aesthetics and colour: a range of surfaces with various designs to suit the most varied of styles. High-quality materials, attention to detail and ease of conversion are the distinctive features of Florim products, guaranteed by more than fifty years of experience and research both technical and aesthetic.

Made from a natural blend of selected ceramic clays and mineral-based colours, **FLORIM stone** sintered surfaces combine the typical characteristics of porcelain stoneware - long-lasting and stable, resistant to high temperatures, atmospheric stress and UV rays, waterproof, highly resistant to stain and scratches, hygienic and easy to clean - with the appearance of natural stone, concrete, oxidised metals or simply plain colors.

\* Thickness with reference to ceramic material; the actual thickness of the material and its backing is 6.7 and 12.7 mm, respectively.

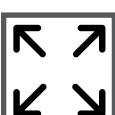
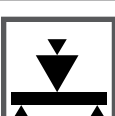

	<b>Resistant to high concentration of acid and alkali</b> <b>Resistant to chemicals used indoor</b>
	<b>Easy to clean</b> <b>stain resistant</b>
	<b>Abrasion resistant</b> <b>Wear resistant</b>
	<b>Water - proof</b>
	<b>High temperatures resistant</b>
	<b>Option for cut to size formats</b>
	<b>High flexural strength</b>
	<b>Hygienic</b> <b>Resistant to fungi and bacteria</b>



## Logistics and Handling / Shipping and storage



### A-frames, Picking Composition and Handling

The slabs produced are positioned on A-frames adequate to transportation and storage, and appropriately labelled.



EMPTY A-FRAMES IN GALVANISED SHEET METAL

EMPTY A-FRAME: 134" x 29½" x H 73" - 286 Lbs

## A-FRAME METAL PICKING PREPARATION

### MANUAL PICKING



## A-FRAME METAL IN-LINE PREPARATION

### AUTOMATIC



## A-FRAME PACKAGING AND LABELING

Identification labels showing the customer's name, material contained on the A-frame and the standards that regulates the export formalities are automatically applied to the outside of the package.

The labels are on both the long and short side to facilitate identification at customs upon opening the CNT.

### COMPLETED A-FRAME READY FOR SHIPMENT



Details of label positioning to facilitate the product recognition inside the container.



## A-FRAME HANDLING

FLORIM stone slabs must be handled (for loading and unloading) and transported with the aid of an appropriate forklift, crane or any other handling device. Always take great care to balance the load during handling and transportation.



- Spread the forklift forks as wide as possible for higher stability of the A-frame during movement.



- Insert the forks under the A-frame, bringing it as close as possible to the forklift mast for higher load stability and to avoid oscillations that may damage the material.

Drive at low speed and, since movement will be in reverse, always check for any obstacles that may damage the material.

## TRUCK LOADING AT FLORIM



Use a forklift with a capacity of at least 8,818 lbs.

Arrange the A-frame in such a way to balance the weight on the vehicle, also following the instructions given by the driver. Insert an airbag between one A-frame and the other if necessary.

## CARGO SAFE LOADING DIAGRAMS

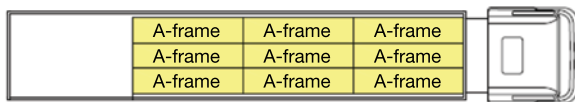

POSSIBLE AVAILABLE SPACE

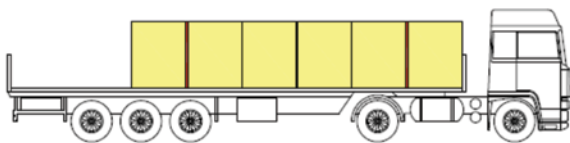

A-FRAME MEASUREMENTS 134" x 29½" x H 73"

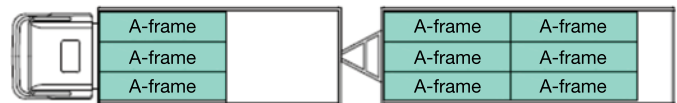

POSSIBLE AVAILABLE SPACE

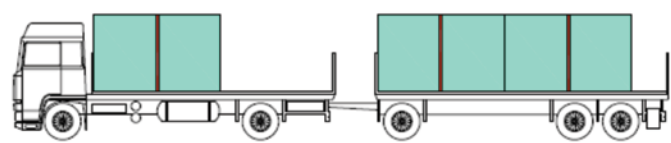

A-FRAME MEASUREMENTS 134" x 29½" x H 73"

## MAKING THE TRUCK CARGO SAFE



Once loaded, check to ensure that the hauler secures the A-frames to the truck bed with straps.

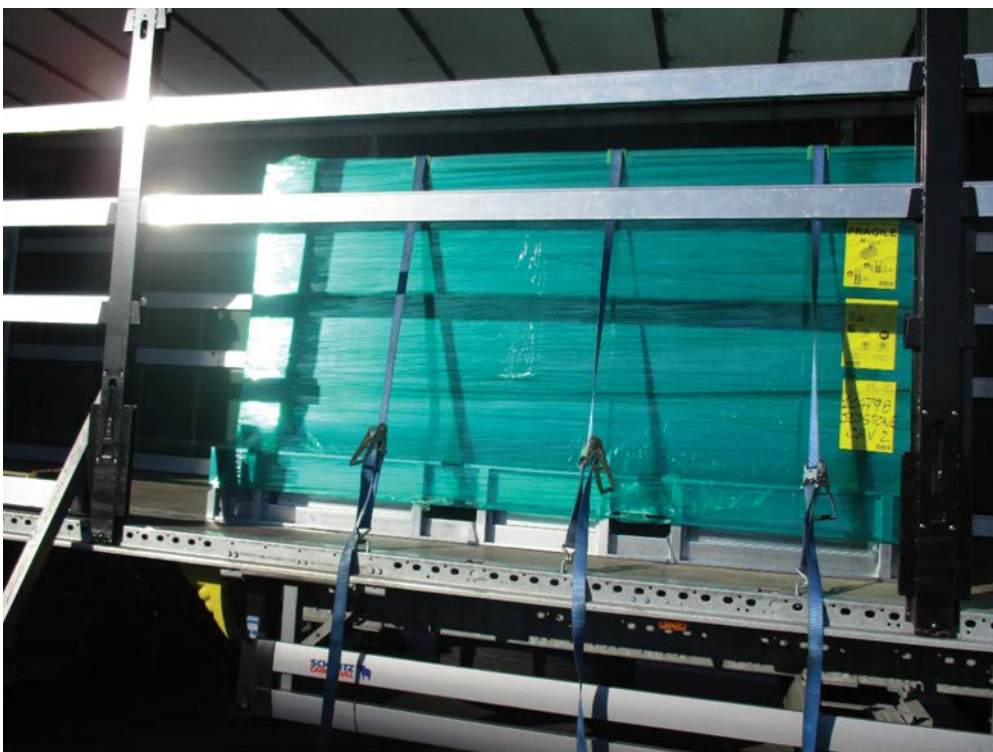

## CONTAINER LOADING AT FLORIM



Use a forklift with a capacity of at least 13,227 lbs and equipped with 106" forks.

The forks should be inserted from the short side, arranging the A-frame on the container in accordance with the certified loading diagram.

## INDICATIVE CONTAINER LOADING DIAGRAMS

### A-FRAMES LOADING DIAGRAM - 20' CNT

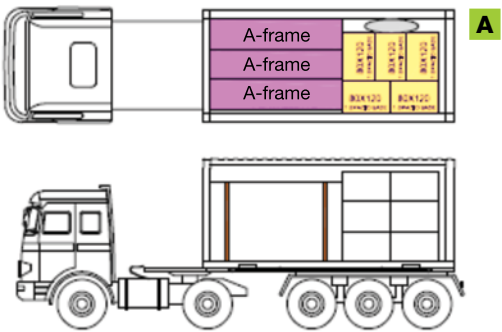

**A-FRAME  
MEASUREMENTS**  
134" x 29½" x H 73"

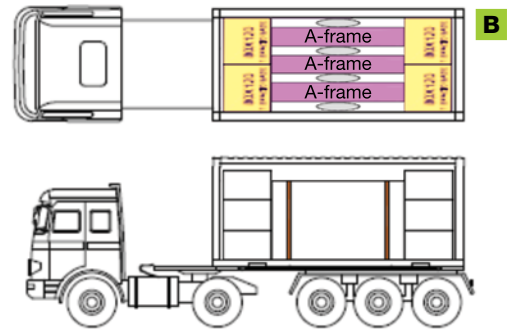

### A-FRAMES LOADING DIAGRAM - 40' CNT

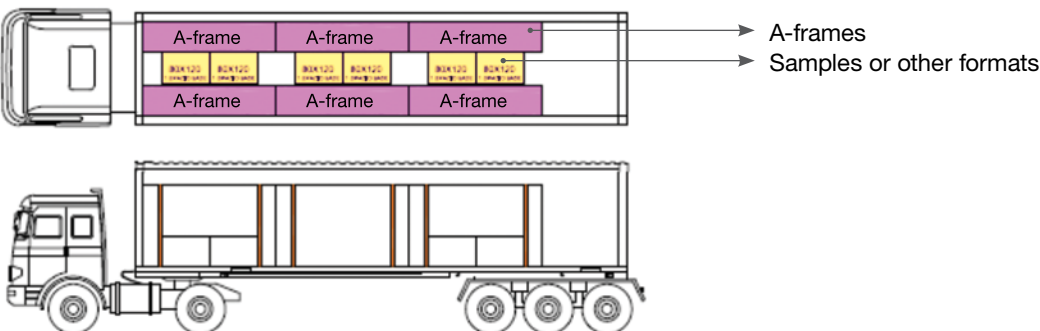

## MAKING THE CONTAINER CARGO SAFE



20' CONTAINER LOAD

A-frames adjacent to the walls are secured to the container using appropriate straps.

The central A-frame is secured in position with air bags.

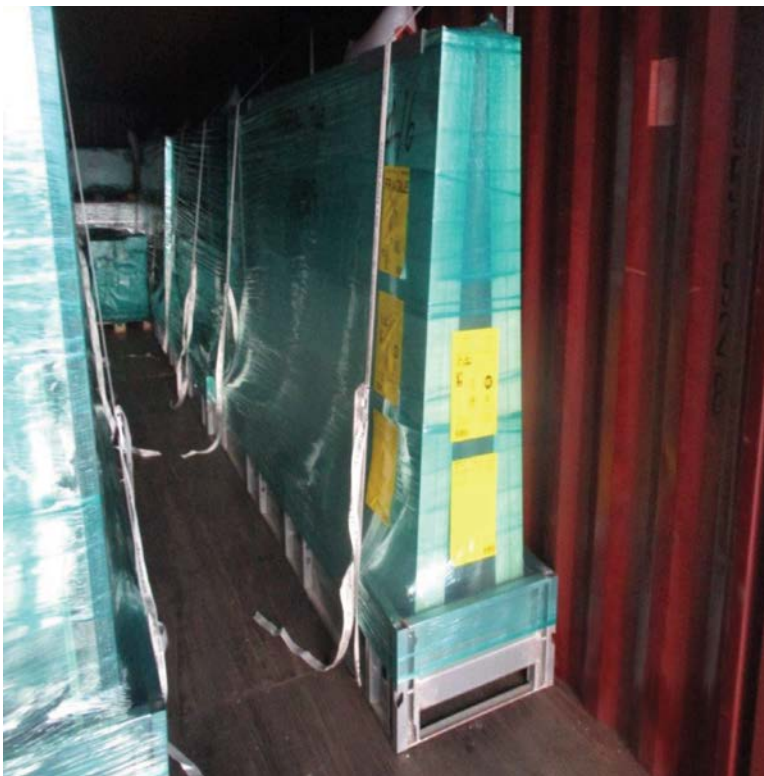

40' CONTAINER LOAD

## OPENING PACKAGING



Extract the safety hook and turn it 90° (one per side) to secure the slab pack.

Then cut the wrap on the narrow side before proceeding with the removal of the slabs.

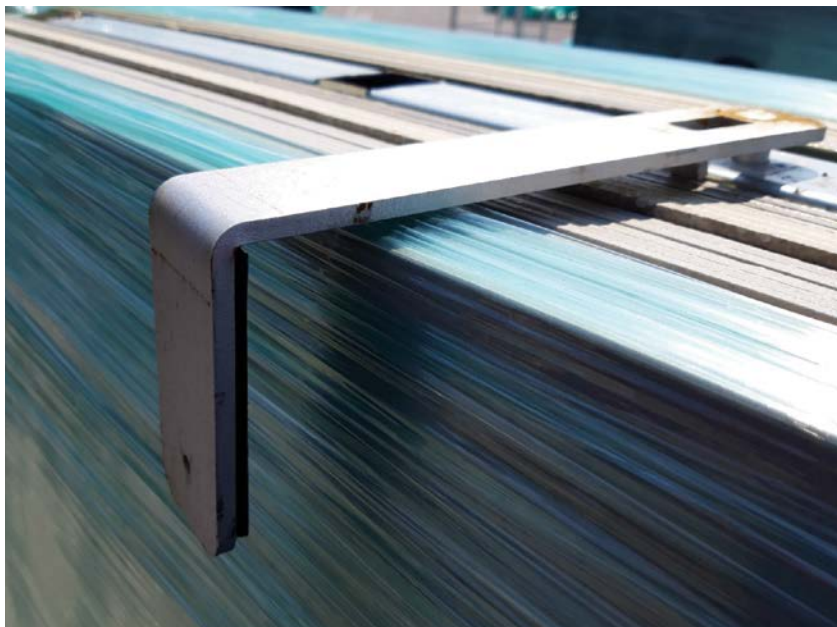

## SLAB HANDLING

Any major blows and bumps could cause a material breakage. Stack multiple slabs only if they are all the same size. Avoid any slab to be positioned on any smaller slabs or leftovers and check there is no empty space between them. Do not place any other material on top of slabs when moving the slabs, always be careful to prevent shocks or bumps which could cause chipping and breakage of the slabs. Pick up carefully any single slab positioning the gripper in the middle strictly within the weight limits specified for your equipment.

To pick up multiple slabs a lifting beam is essential, Use canvas straps coated with cut-resistant rubber and properly spaced taking all the suitable safety measures. It is advisable to place a wooden spacer, larger than the slab thickness pack, both at the bottom and on the top, so to decrease the weight and pressure applied to the slabs. Do not use steel cables or chains as these could damage the surfaces and edges of the slab.

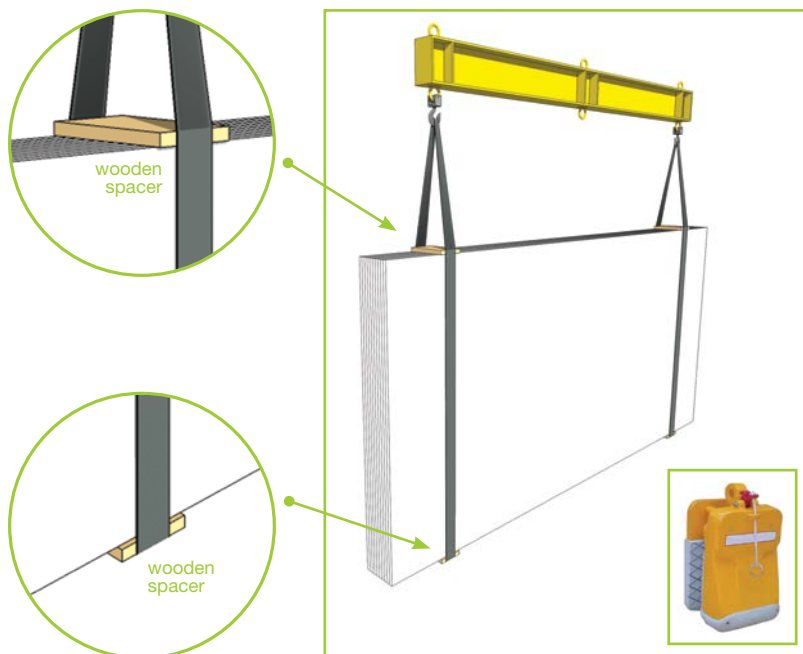

Note:

If storing slabs on A-frame, we recommend using a continuous and rigid resting base (possibly in wood or rubber). If storing outdoors, we recommend covering the slabs with a waterproof canvas.

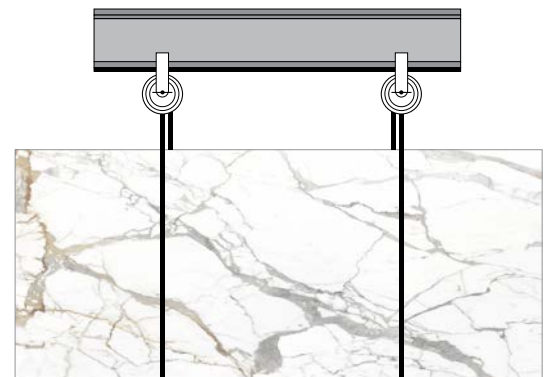

Cut pieces may be sharp on their sides and corners and must be handled with extreme care, wearing safety garments.

Any single element (even without holes) must always be uplifted by their edges.

Fabricated material must be packed in crates with bumpers, corner protectors and padded panels to prevent blows.

Unsuitable material chosen for outside crate packaging may cause damage.

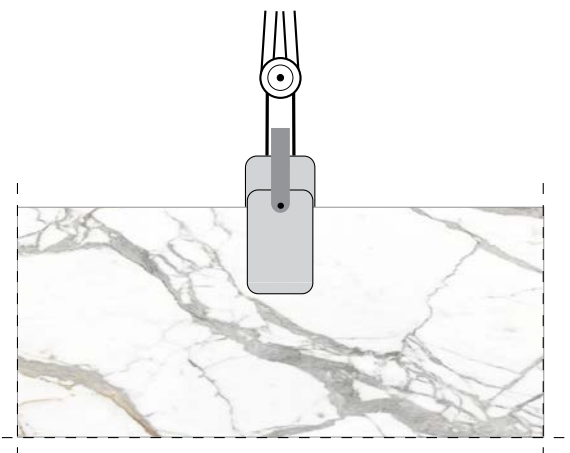

## HANDLING AND PACKAGING

FLORIM stone slabs must be loaded, unloaded and transported with the aid of an appropriate lift truck, crane or other handling equipment. Always be sure to balance the load when handling and transporting it.

Technical Information	U.M.	THICKNESS ¼" Values	THICKNESS ½" Values	THICKNESS ¾" Values
Slab surface area	sqf	56.83	56.83	56.83
Sqf SU slab surface	sqf	55.11	55.11	55.11
Slab weight	lbs	168.60	337.1	561.80
Weight per sqf	lbs	3.06	6.12	10.19
Slabs per A-frame	nr.	44	22	12
Sqf per A-frame	sqf	2,500.67	1,250.34	682.00
Sqf per SU A-frame	sqf	2,424.89	1,212.45	661.33
A-frame weight	lbs	297.60	297.60	297.60
Complete A-frame weight	lbs	7,716.20	7,716.20	7,054.80
A-frame dimensions	in	134" x 29½" x H 73"	134" x 29½" x H 73"	134" x 29½" x H 73"

The carrier must carefully and appropriately fasten the material when loading.

## TRUCK

**Capacity: 30,864.7 lbs**

\* The reported figures depend on the tractor engine dimension

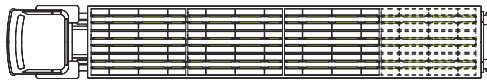

Technical Information	U.M.	THICKNESS ¼" Values	THICKNESS ½" Values	THICKNESS ¾" Values
Total number of A-frame that may be loaded*	nr.	max 3	max 3	max 3
Total gross weight	lbs	max 23,148.50	max 23,148.50	max 21,164.40
total sqf	sqf	7,502.02	3,751.01	2,046.00
total sqf SU	sqf	7,274.68	3,637.34	2,314.67

## SEMI-TRAILER

**Capacity: 52,910.9 lbs**

Technical Information	U.M.	THICKNESS ¼" Values	THICKNESS ½" Values	THICKNESS ¾" Values
Total A-frame that may be loaded	nr.	max 6	max 6	max 6
Total gross weight	lbs	max 46,297.00	max 46,297.00	max 42,328.70
total sqf	sqf	15,004.04	7,502.02	3,446.18
total sqf SU	sqf	14,549.37	7,274.68	3,968.01



**20' BOX CONTAINER\*\***

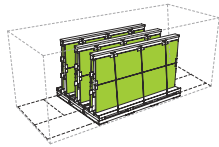
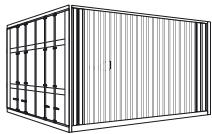

Technical Information	U.M.	THICKNESS ¼" Values	THICKNESS ½" Values	THICKNESS ¾" Values
Total A-frames that may be loaded	nr.	max 3	max 3	max 3
Total slabs per container	nr.	max 132	max 66	max 36
Total gross weight	lbs	max 23,148.50	max 23,148.50	max 21,164.40
total sqf	sqf	7,502.02	3,751.01	2,046.00
total sqf SU	sqf	7,274.68	3,637.34	1,984.00

**40' BOX CONTAINER\*\***

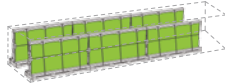

Technical Information	U.M.	THICKNESS ¼" Values	THICKNESS ½" Values	THICKNESS ¾" Values
Total A-frames that may be loaded	nr.	max 6	max 6	max 6
Total slabs per container	nr.	308	154	64
Total gross weight	lbs	max 54,013.20	max 54,013.20	max 42,328.70
total sqf	sqf	1,7504.71	8,752.35	4,092.01
total sqf SU	sqf	1,6974.26	8,487.13	3,968.01

SU: Usable Surface - Material is supplied not rectified, with approximate dimensions of 64½" x 127½".  
An Usable Surface of 63" x 126" is guaranteed after rectification.

\*\*While handling a container load, the weight limits imposed by any port of entry must be duly respected.

The information contained in the above tables are as accurate as possible, but should not be considered legally binding.  
Florim Ceramiche S.p.A. reserves the right to change and update packaging (A-frame type, size, number of slabs, etc.) at any time with no advance notice.

## ACCESSORY DETAILS



### A-frame

FLORIM stone A-frame made of shaped and welded galvanised sheet metal, with vertical rubber resting surface for the slabs.



### Additional characteristics

The FLORIM stone A-frames are easily stackable, letting you save space when storing empties.

They have a hooking point to facilitate unloading of the container.

Note: the purpose of the hooks is solely to drag the stand. They cannot be used to lift it.



## ACCESSORY DETAILS

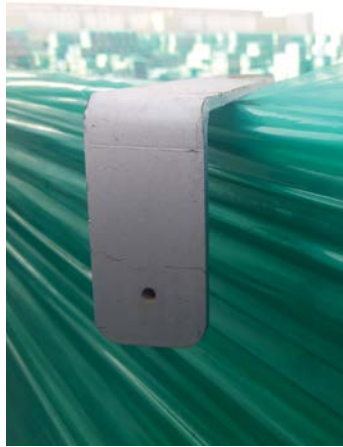

### Safety features

FLORIM stone A-frames have a containment system for the pack of slabs consisting in two mechanical clips per unit.

Always secure the slabs when opening the A-frame.

### Safety of the cargo in the container

Storage of the A-frames in the containers requires the following:



**a.** Securing the two external A-frames with high resistance straps and buckles to the specific hooks.



**b.** Inserting air bags between the A-frames and between the container walls and the A-frames.

## CORDSTRAP CERTIFIED LOADING PLAN FOR FLORIM stone SLABS 20'

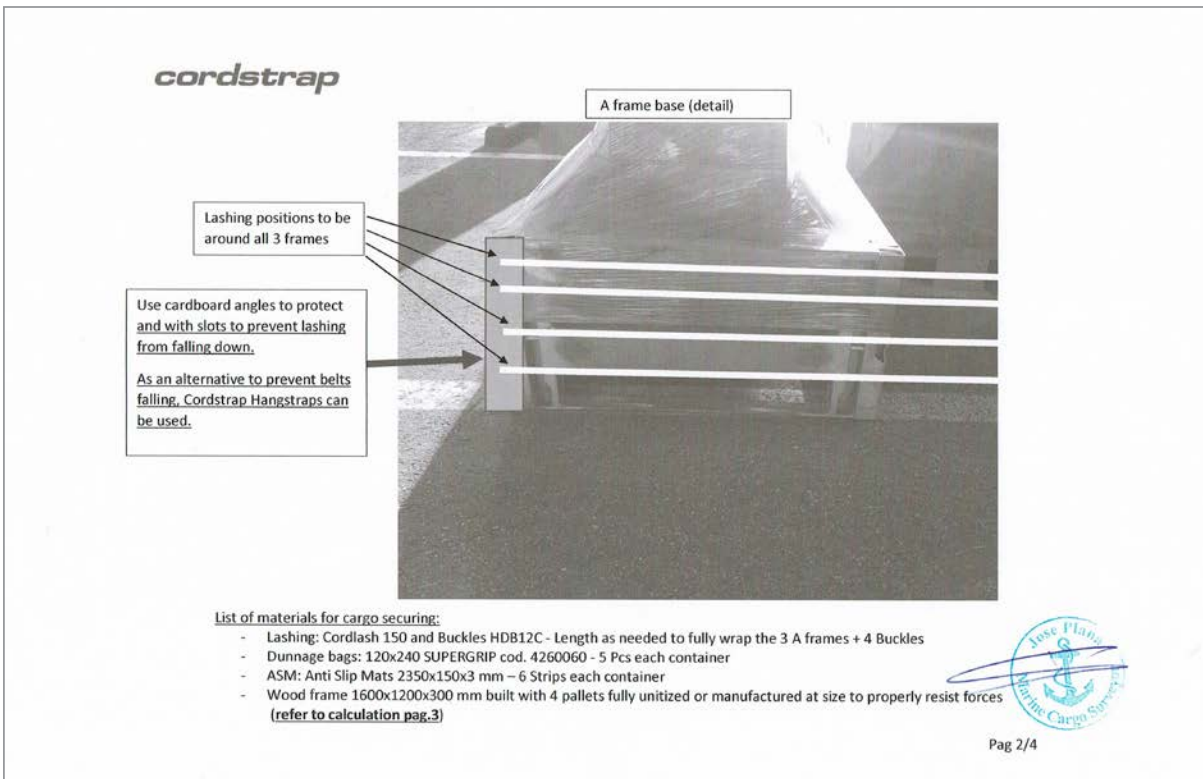
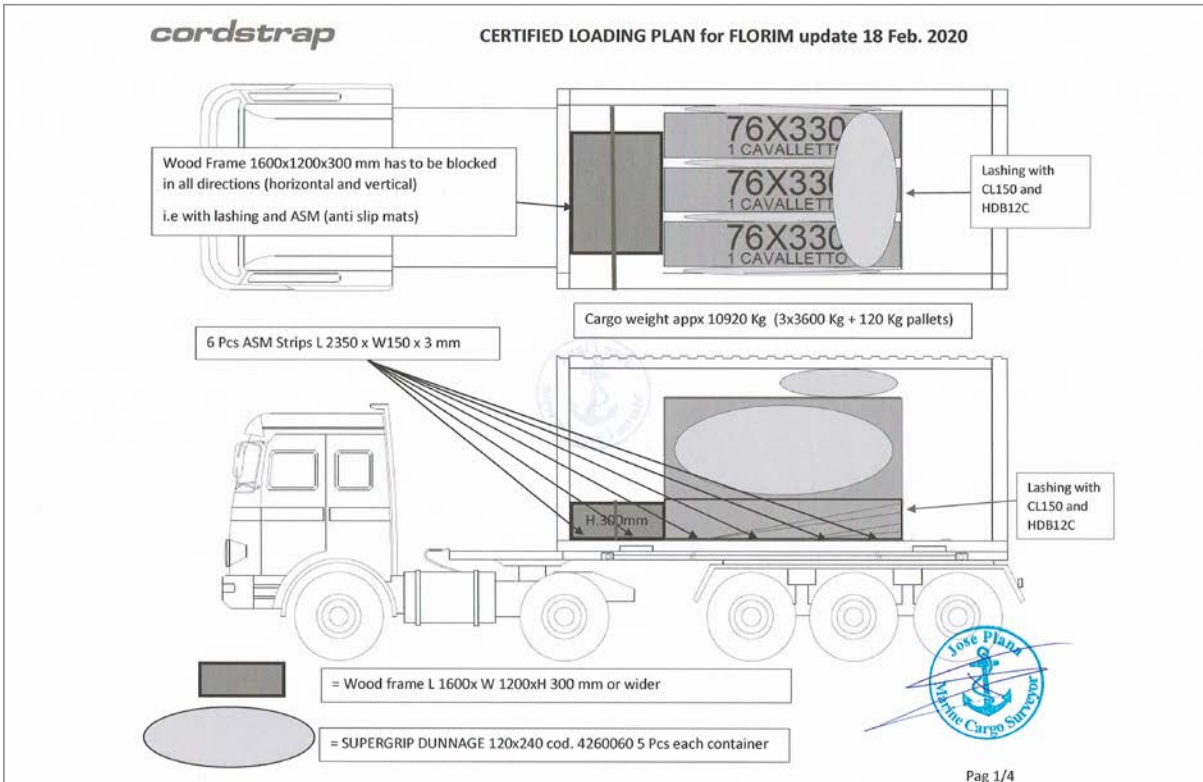

## CORDSTRAP CERTIFIED LOADING PLAN FOR FLORIM stone SLABS 20'

### cordstrap

#### Calculations for Loading Plan

A-frames with ceramic tiles in a 20ft ISO container

A-frames are 3,3 m long and 0,75 m wide

A-frames cannot be positioned one after the other, which means that maximum 3 A-frames can be placed, side by side, in a 20ft container.

Each A-frame weighs 3600 kg in total. The total cargo weighs 10800 kg.

Due to weight distribution the A-frames need to be positioned near the middle of the container.

2 Pairs of Euro pallets are used to create a block between the container head and the A frames. Each pair has one pallet on top of the other unified using CC strap. Both pairs are positioned side by side and are kept in place with a top-over lashing (tie-down). A 80x120 cm Euro pallet weighs up to 30 kg per pieces, so this adds 120 kg to the load weight: 10.920 kg in total

The A-frames are secured using 4 D rings (2 on each side) using Cordlash 150. The MSL of a system of Cordlash 150 with HDB12C is 2500 daN, but is restricted by the MSL of the D-rings in the container. This implies the MSL of the Cordlash-HDB12C system using 2 ISO container D rings is 2000 daN.

The 2 D-rings used are at approximately 1/3 and 2/3 of the length (1,1 and 2,2 m) of the A-frame. At a height of 10 and 30 cm

This means the average angle of the first system ( $\alpha_{avg1}$ ) is 6°.

This means the average angle of the second system ( $\alpha_{avg2}$ ) is 8°.

The secured cargo weight in ton,  $m$ , is calculated as:

$$m = \frac{MSL \cdot \cos \alpha_{avg1} + MSL \cdot \cos \alpha_{avg2}}{(c_h - c_v \cdot \mu \cdot f_d) \cdot g \cdot 100}$$

where:

$c_h$  Horizontal acceleration coefficient

$c_v$  Vertical acceleration coefficient

$\mu$  Friction factor

$f_d$  Conversion factor for dynamic friction

$g$  Gravity acceleration 9.81 [m/s<sup>2</sup>]



### cordstrap

For sea (area C) transport with  $c_h = 0.4$  backward,  $c_v = 0.2$  downwards, the friction factor  $\mu = 0.20$  and the dynamic friction factor  $f_d = 0.75$  the following secured cargo weight in ton is obtained:

$$m = \frac{2000 \cdot \cos 6^\circ + 2000 \cdot \cos 8^\circ}{(0.4 - 0.20 \cdot 0.20 \cdot 0.75) \cdot 9.81 \cdot 100} = 10.9 \text{ ton}$$

For road transport (doors to the back) with  $c_h = 0.5$  backward,  $c_v = 1.0$  downwards, the friction factor  $\mu = 0.20$  and the dynamic friction factor  $f_d = 0.75$  the following secured cargo weight in ton is obtained:

$$m = \frac{2000 \cdot \cos 6^\circ + 2000 \cdot \cos 8^\circ}{(0.5 - 1.0 \cdot 0.20 \cdot 0.75) \cdot 9.81 \cdot 100} = 11.6 \text{ ton}$$

According to the above calculation, we are very close to the limit for sea transportation, considering 3 A-frames and 4 Euro pallets with a total weight of 10920 kg appx.

For this reason we RECOMMEND the use of Anti Slip Mats (ASM see pag.1)

When applying anti-slip mats of 6µ, the secured weight For sea (area C) transport with  $c_h = 0.4$  backward,  $c_v = 0.2$  downwards, the friction factor  $\mu = 0.60$  and the dynamic friction factor  $f_d = 0.75$  the following secured cargo weight in ton is obtained:

$$m = \frac{2000 \cdot \cos 6^\circ + 2000 \cdot \cos 8^\circ}{(0.4 - 0.20 \cdot 0.60 \cdot 0.75) \cdot 9.81 \cdot 100} = 13.0 \text{ ton}$$

For road transport (doors to the back) with  $c_h = 0.5$  backward,  $c_v = 1.0$  downwards, the friction factor  $\mu = 0.20$  and the dynamic friction factor  $f_d = 0.75$  the following secured cargo weight in ton is obtained:

$$m = \frac{2000 \cdot \cos 6^\circ + 2000 \cdot \cos 8^\circ}{(0.5 - 1.0 \cdot 0.60 \cdot 0.75) \cdot 9.81 \cdot 100} > 30.0 \text{ ton}$$

This is sufficient for 3 A-frames and 4 Euro pallets with a total weight of 10920 kg, providing additional safety than securing without the use of anti-slip mats, which is to close to the limits

The performances of this loading plan are granted only by the use of Cordstrap certified products as indicated above

All contents are property of Cordstrap LLC and cannot be copied or used without prior authorization



## CORDSTRAP CERTIFIED LOADING PLAN FOR FLORIM stone SLABS 40'

# cordstrap

CERTIFIED LOADING PLAN for FLORIM 11 Feb. 2020

6 Pcs A Frame in 40' Container

Each frame L. 3400 mm W. 740 mm H.2000mm Weight 3600 Kg appx

MASS 21,6 TON - MASS TO SECURE 10,3 TON.

GFORCE D18 → 4,32 TON

FRCTION USING AN 0,6 → 12,6 TON

HOISTING & EXTRACTOR SYSTEM GUARANTEE THE CARGO PROTECTION



cordstrap

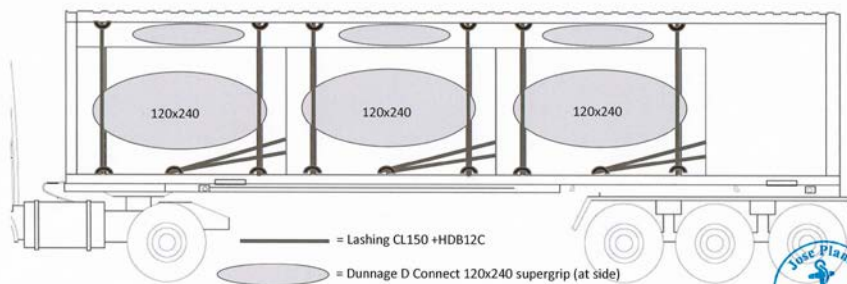
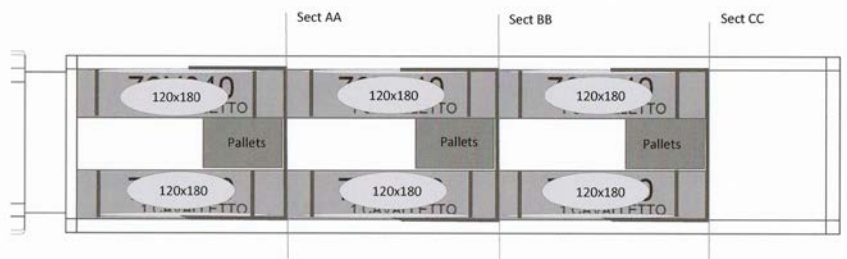

— = Lashing CL150 +HDB12C

○ = Dunnage D Connect 120x240 supergrip (at side) and 120x180 (on Top)

■ = 2pallets unitized L 1200xW 800xH 300 mm

Pag 2/5



## CORDSTRAP CERTIFIED LOADING PLAN FOR FLORIM stone SLABS 40'

*cordstrap*

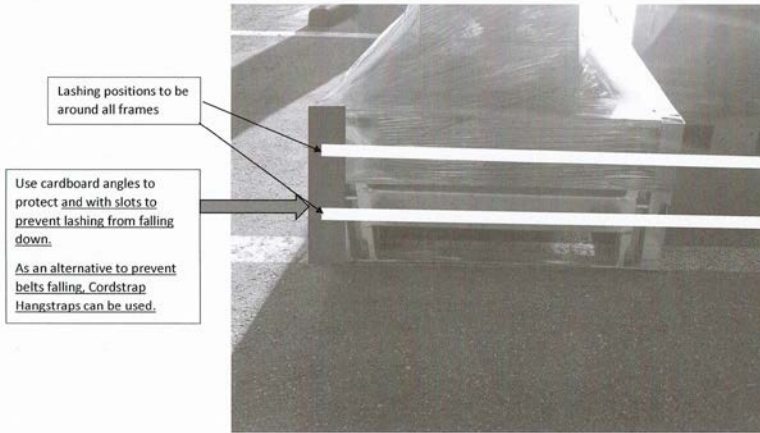

**List of materials for cargo securing:**

- Lashing: Cordlash 150 and Buckles HDB12C - Length as needed to + Buckles
- Dunnage bags: 120x240 SUPERGRIP cod. 4260060 - 6 Pcs each container
- Dunnage bags: 120x180 D-Connect cod. 4270230 - 6 Pcs each container
- ASM: Anti Slip Mats 2350x250x8 mm - 9 Strips each container
- 3 Wood frames 1200x800x300 mm built with 2 pallets each, fully unitized or manufactured at size to properly resist forces



*cordstrap*

SECTIONS AA BB CC

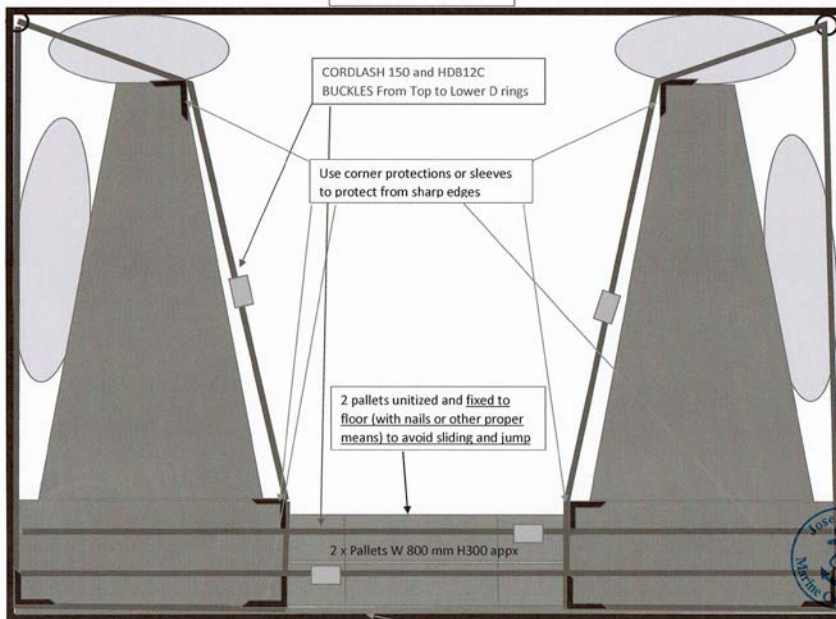

## CORDSTRAP CERTIFIED LOADING PLAN FOR FLORIM stone SLABS 40'

*cordstrap*

Positions of ASM strips 2350x250x8 mm (Anti Slip Mats)

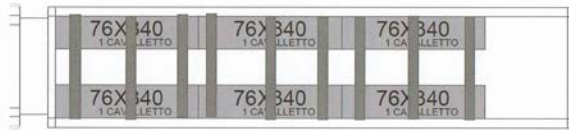

The use of 8 mm thick anti slip mats, is to allow sufficient space between container floor and frame, for lashing to go underneath.

The performances of this loading plan are granted only by the use of Cordstrap certified products as indicated above

All contents are property of Cordstrap LLC and cannot be copied or used without prior authorization



Pag 5/5



## RECEIVING AND QUALITY CONTROL

### RECEIVING OF GOODS

- Check the correspondence between transport document, order and the goods received.
- Check the external integrity of the packaging (absence of visible impact or deterioration).
- Open the package, checking at least the first slab (shade, appearance), as well as checking the condition of the material (see handling manual).

### DIMENSIONS

#### Approximate nominal dimensions

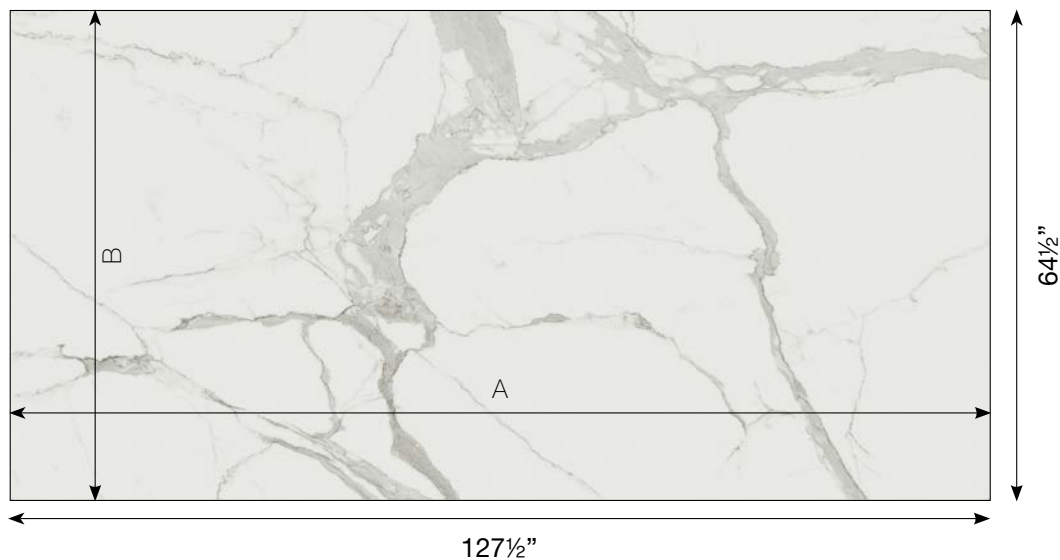

Dimensions	Width in	Length in
Approximate	64 1/2"	127 1/2"
Useful for 1/4"	63"	126"
Useful for 1/2"	63"	126"
Useful for 3/4"	63"	126"

### THICKNESS

Nominal thickness	Tolerance mm
6,7 mm - 1/4" mat backing	+/- 0,3
12,7 mm - 1/2" mat backing	+/- 0,6
20 mm - 3/4"	+/- 1,0

## RECEPTION AND QUALITY CONTROL

### SURFACE APPEARANCE

#### Before fabrication

- Check every single slab. **FLORIM stone** slabs are obtained by processing raw materials of natural origins. Observation should be made at a distance of 24", perpendicularly to the surface and in natural light. Small imperfections are considered to be acceptable with the following limitations:
- Contamination (points of colour other than the graphics in strong contrast with the background colour): up to 1 mm.
- Raised bumps (low contrasting colour with the background): up to 1/8" in diameter and 1/16" thick with respect to the background
- For the PURE WHITE colour only, black points up to 1/16" in diameter are allowed.  
The concentration of points in contrasting colour smaller than one mm in diameter is limited to 6 per 4"x4" square.

### FLATNESS

- The flatness of the slab should be checked in the following ways:
  - Rest the slab on a perfectly horizontal and stable surface.
  - Using an aluminium straight-edge, check the shifts in the central point of the slab and/or at the ends.
  - Criteria for acceptance: see technical data sheets from page 42

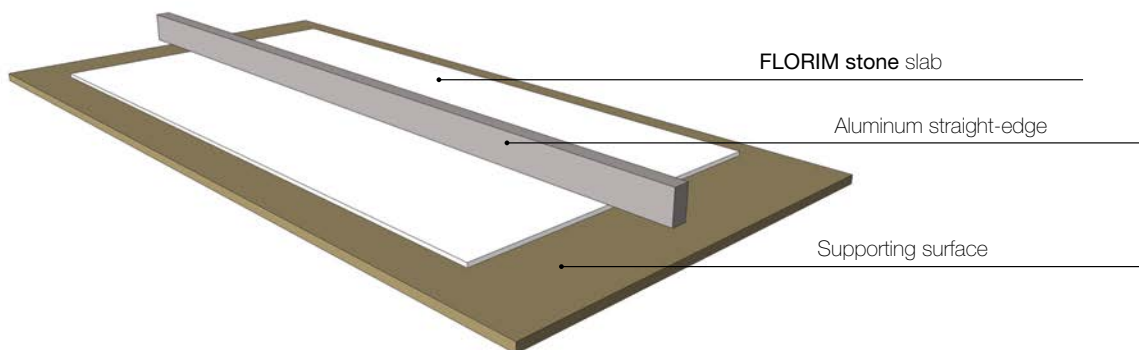

### IDENTIFICATION LABEL



Every single slab is stamped on both sides with: code, article and identification colour of the lot.

## DESIGN

In the design drawing, which may include the cutting of one or more slabs, the following must be taken into consideration:

- The design distances must be confirmed by measurements on the job site.
- The minimum distance permitted between holes or cut-outs and/or the edge of the slab is 2" (we recommend leaving 3" of space between cooking surface and back splash for gas cooking surfaces).

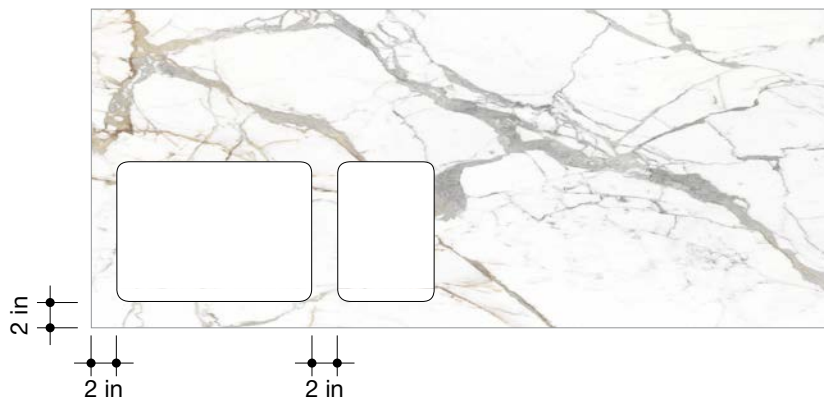

- All the internal corners of holes and cut-outs must have a constant radius, equal to at least 3/16".

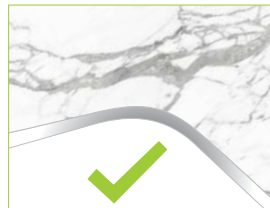

- If the project includes the use of multiple slabs, assess the direction of the material graphic.
- Obtaining complex shapes (e.g. "L" or "C") from a single slab (monolithic top) leads to the creation of a covering element that will be more fragile, both in handling and in installation and which could be more susceptible to the stress generated by the structure below. Evaluate the option of subdividing the surface into multiple elements.
- If multiple slabs must be processed in order to obtain graphic continuity (e.g. book match), take care in cutting the portions to be paired. As with natural stones, processing of this type, even when carried out at the highest trade standards, can imply slight graphic shifts. Florim will not be held liable for this.

## DESIGN

- An empty space of at least 1/8" that functions as an expansion joint must be provided between the product and the wall against which it is rested, for seaming 1/16" between the pieces is recommended.



- Flush-mount housing and cut-outs for the elements to be flush-mounted (sinks, cook tops, etc.) must provide an additional perimeter space of about 1/16" that functions as an expansion joint.

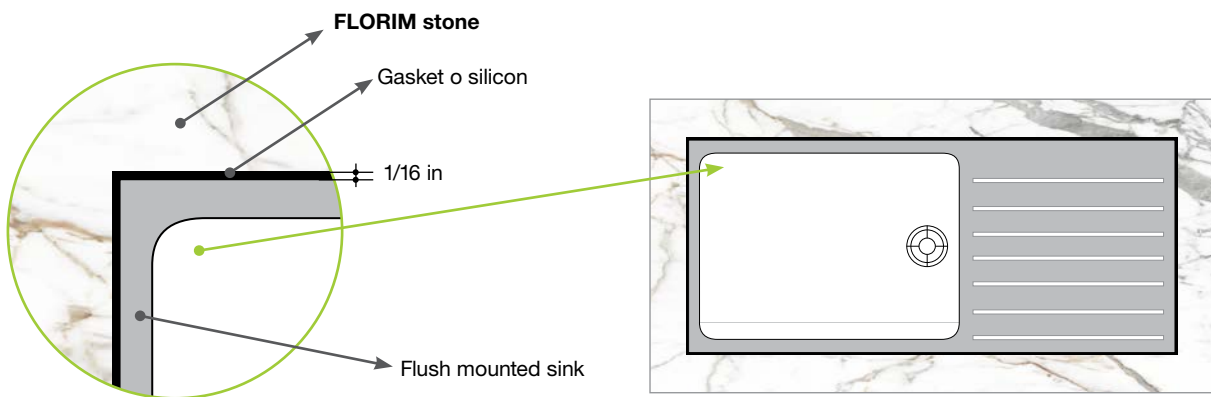

## DESIGN

- If large openings are necessary on the surface (larger than 27"), we recommend providing at the centre of the opening, in the direction of the depth, a pre-incised strip about 2" wide (to be removed after installation) to make handling the surface less critical. **(Photo 1)**

In case of opening to be polished during the fabrication process, we recommend the use of "sink hole saver edge bar" for transportation. **(Photo 2)**

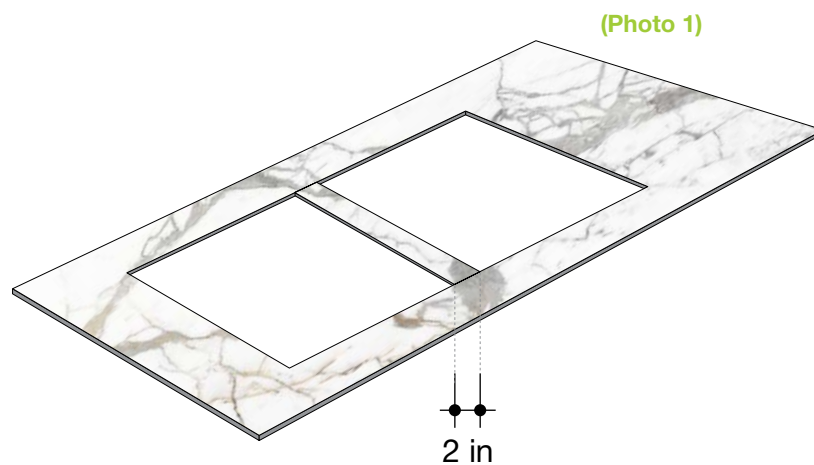

## DESIGN

### SUBSTRUCTURE

FLORIM stone slabs in 1/2" (with mesh backing) and 3/4" thick do not require to be glued continuously to the substrate.

The substrate material must be rigid, dimensionally stable in the conditions of use and with a thermal expansion coefficient similar to that of FLORIM stone.

For both indoor and outdoor applications, do not use supports in wood, composite materials (i.e. engineered stone), or in any case, materials with thermal expansion coefficient excessively different than that of ceramic material (6/7 M°K-1).

The 1/2" thickness material with mat backing must be glued to the substrate (full perimeter of the cabinet bases) on a 24"x24" grid.

The 3/4" thickness material must be glued to the substrate (full perimeter of the cabinet bases) on a 36"x36" grid.

Gluing to the structure must be carried out with a continuous bead of silicone or another elastic adhesive.

### ACCESSORY ELEMENTS

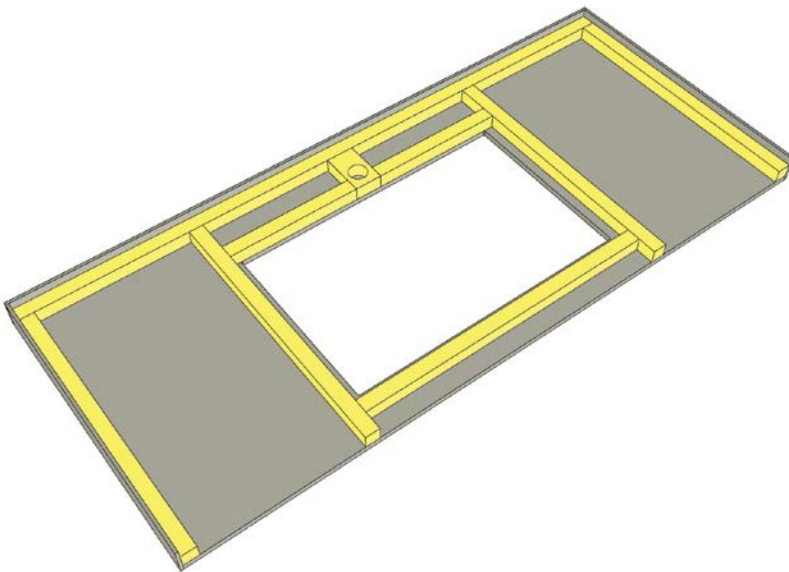

Along the internal perimeter of the sink cut-outs and cook tops made with 1/2" sheets with mat backing, reinforcements must be positioned, arranged in such a way so as to load the additional weight on the structure of the cabinets.

For example, use strips in granite, porcelain stoneware or high density polyurethane of about 4" in width at a length of about every 24" on the back of the countertop using silicone.

These strips provide further rigidity useful in transport and installation. Flush-mount housing cannot be used for 1/4" thick FLORIM stone slabs.

Large sinks or sinks placed under the countertop must be additionally supported with sink braces or sink support systems secured to the cabinet.

## DESIGN

### OVERHANG INDICATIONS

The 1/4" thick FLORIM stone slabs, even if supported, are not suitable for the creation of overhang.

The 1/2" and 3/4" thick FLORIM stone slabs can be used for overhang design.

Attention: the creation of overhang is not recommended in the case of holes or openings on the slab positioned at less than 6" from the edge of the cabinet. In case of holes or openings at a distance between 6" and 24" from the edge, the depth of the overhang should be reduced 50% with respect to the indications in the points below.

FLORIM recommends:

- Overhang up to 6" without support for 1/2" thick with mat backing and up to 12" for 3/4" material\*.
- Overhang from 6" to 12" for 1/2" thick with mat backing and from 12" to 18" for 3/4" material only with supports connected to the load-bearing structure of the cabinets or walls. Support have to be placed every 24" for 1/2" thick material and every 36" for 3/4" thick material.\*.
- To create overhangs, rigid support structures must be prepared.

\*in the described configuration, FLORIM stone withstands loads as per the table:

Overhang	1/2" thk.	3/4" thk.
6"	1,102.30 lbs	3,086.50 lbs
12"	-	1,543.20 lbs
12" with 8" long brackets equally spaced	1,102.30 lbs	2,204.60 lbs
18" with 12" long brackets equally spaced	-	1,430.00 lbs

**Notes:** The data on the table stem from a mathematical calculation and are to be considered approximate. The load calculated refers to the static load, distributed evenly along the span between the brackets.

Bear in mind in the design phase:

- possible overloads due to dynamic loads
- impacts (see technical table for the impact resistance data)
- safety: the creation of overhang for tables or countertops is usually associated with the total or partial removal of the mat backing from the 1/2" thick material, with consequent lower capacity to withstand impact by the slab.

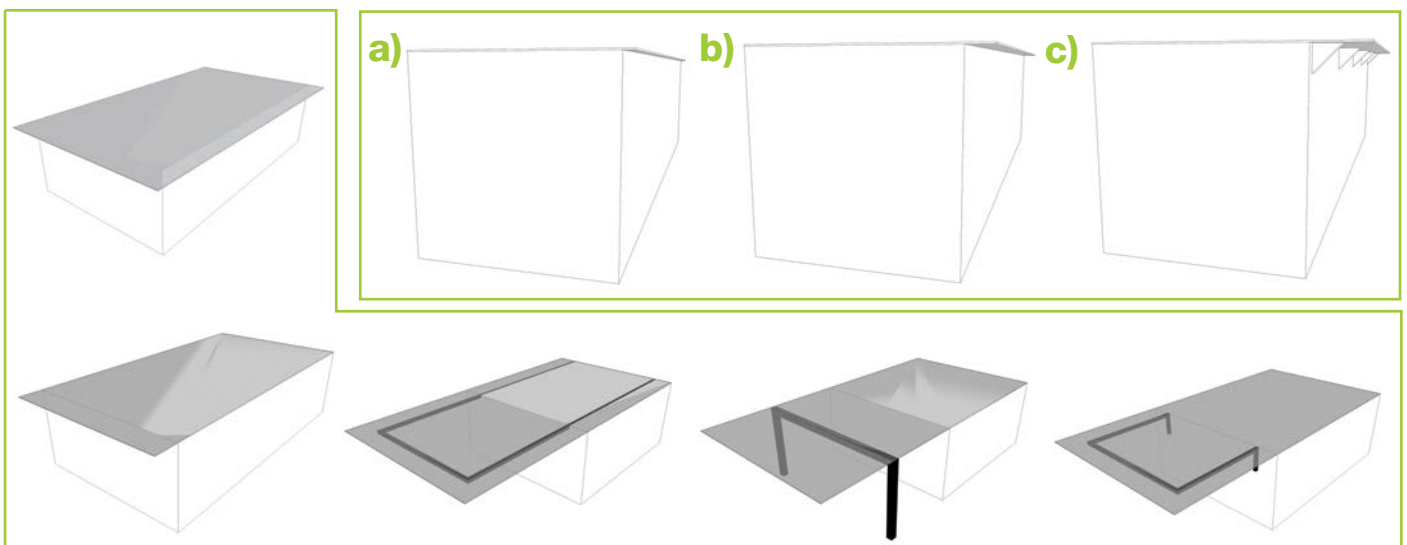

## FABRICATION

### CUTTING

Before proceeding with any fabrication, the slab perimeter must be entirely trimmed by at least 5/8".

We recommend using a bridge saw after ensuring that the workbench is clean and free from debris, in good condition and flat.

The trimming sequence is:

The entire length of both horizontal sides **(1-2)**

The entire height of both vertical sides **(3-4)**

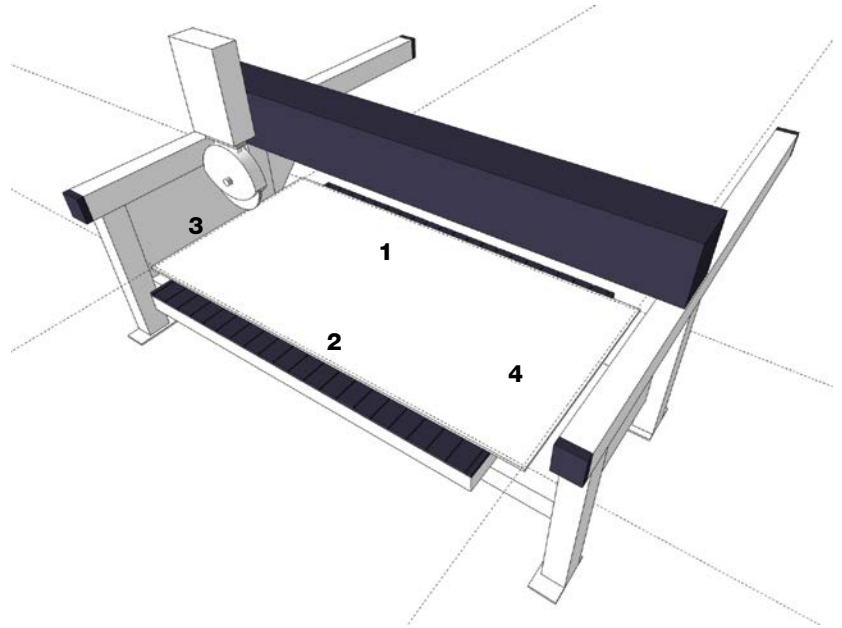

### Instructions and parameters for bridge saw

Thicknesses	Blade Diameter	Range Rpm	Straight cut**	Feed rate Mitered cut**
1/4", 1/2" and 3/4"	12"	2300 - 2500	47" to 63" for 1/4" and 1/2"	27" to 35" for 1/4" and 1/2"
	14"	2000 - 2200		
	16"	1700 - 1900	31" to 39" for 3/4"	24" to 27" for 3/4"
	18"	1400 - 1800		

\*\* Reduce the speed by 50% for 8" at the start and end of the cut.

Note that the parameters provided are approximate and depend on the type of blade and machine used; follow the supplier's specific instructions.

Use a bridge saw with a frequency variator to adjust revolutions per minute and obtain precise monitoring. When cutting corners or cut outs, first drill a hole at the point of intersection of the straight cuts, using a tool of at least 3/8" diameter.

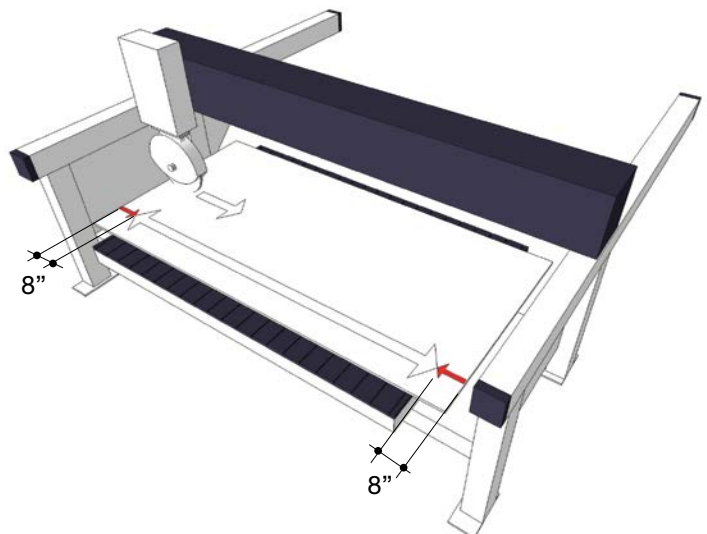



## FABRICATION

### DRILLING HOLES/CUT-OUTS

#### a. With bridge saw

We suggest obtaining the backsplashes, strips and the other straight portions necessary from the external parts of the slab.

To make cut-outs on the slab, trace guide lines and drill the holes at the 4 corners of the desired rectangle using a tool with a diameter of at least 3/8".

Carry out the cut starting from the innermost long side of the slab being processed.

We recommend using abundant water, directing the jet onto the point where the tool is in contact with the material.

**(Photo A)**



**1 and 2** Draw guide lines and drill holes at the 4 corners of the desired rectangle .

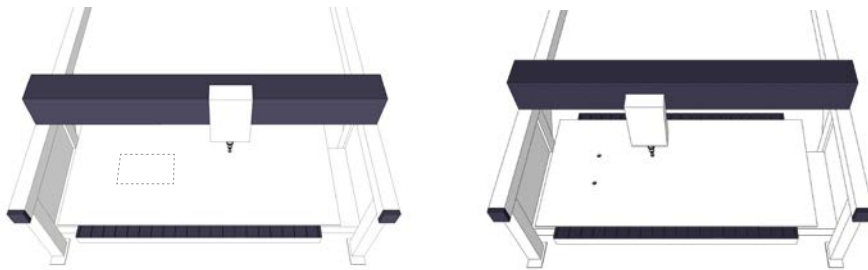

**3** Make the cut, starting on the longer sides first.



**4** Always allow a minimum of 2" between the hole and the edge of the slab.

**5** Maintain a minimum radius of 3/16".

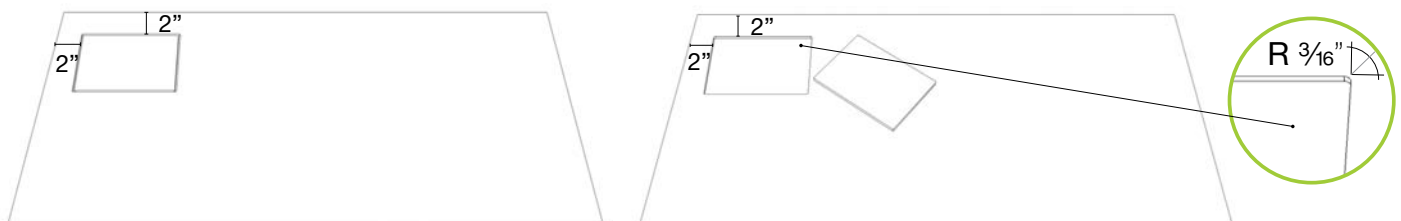

## FABRICATION

### DRILLING HOLES/OPENINGS

#### b. With water-jet

Carry out water-jet cutting of the previously trimmed slab (with bridge saw or water-jet).

Check the flatness of the workbench and the condition of the fins.

We recommend maintaining the water level about 1/8" above the fins.

Wherever possible, we suggest avoiding interrupted cuts and beginning to cut starting from the outside of the slab perimeter.

To make openings or holes, carry out the "piercing" inside the opening, connecting to the side with a slight curvature (see image).

Start the cut from the innermost side of the cut-out with respect to the slab.

Avoid sharp corners, making corners with a radius 3/16".

The opening must be at a minimum distance of 2" from the edge of the slab.

For openings greater than 24"x20", we recommend carrying out a few holes or a geometry inside the cut-out in order to avoid excessive load near the point where the cut will join the final geometry being removed.

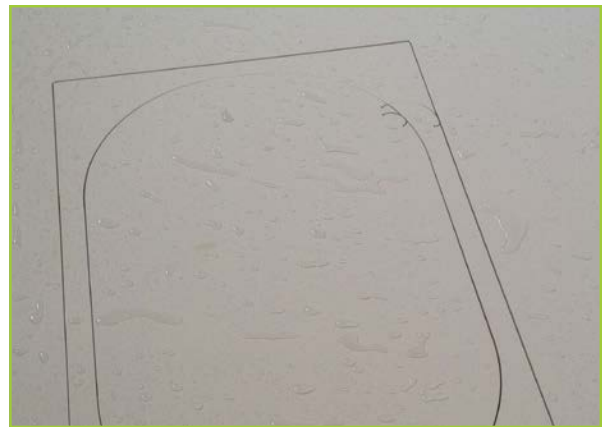
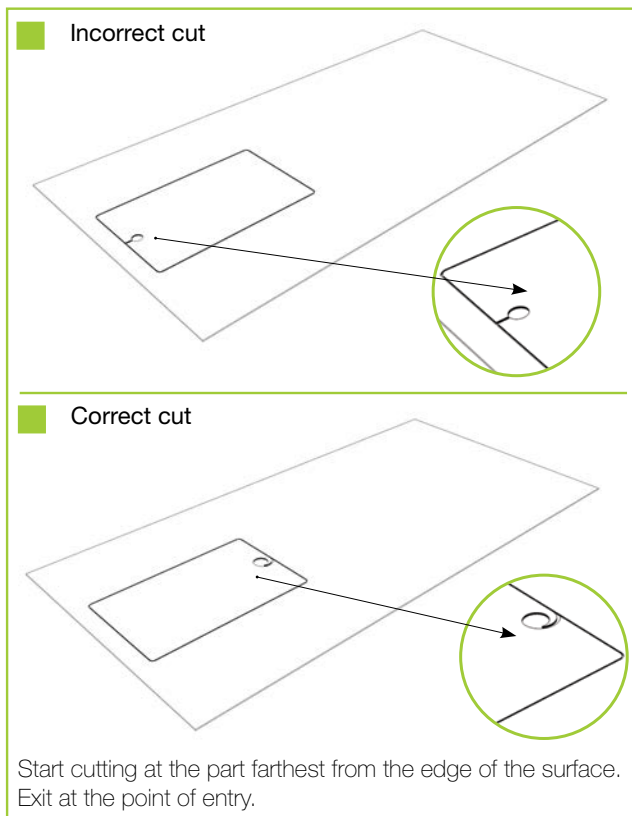

Thicknesses	Feed rate inch/min
1/4"	31" to 51"
1/2"	31" to 51"
3/4"	19" to 31"

#### Approximate figures for working water jet cutting with thicknesses of 1/4", 1/2" and 3/4":

Abrasive 0.8 to 1 lbs/min.

Entry pressure 17000 to 19000 PSI.

Cutting pressure 50700 to 54000 PSI.

Adapt speed according to the desired quality.

Always verify the conditions of the supporting bars.

- 1/8" above the supporting bars.
- When possible, always start the cutting from the outside of the slab limiting the need of piercing.
- Lower is the cutting speed, higher is the quality of the final cut.

## FABRICATION

### DRILLING HOLES/OPENINGS

#### c. Indications and Parameters for CNC

Position the suction cups in an adequate number in order to provide the best possible resting surface for the countertop, arranging the supports in such a way so as to prevent the cut pieces from falling. To carry out openings on the slab, drill a first hole in the area inside to be cut, using a suitable core bit and carrying out the cut using the appropriate finger bit, connecting to the side with a slight curvature (see image).

Start the cut from the innermost side of the cut-out with respect to the slab.

We recommend using abundant interior and exterior water, directing the jet onto the point where the tool is in contact with the material.

Do not use other tools which are not suction cups or Teflon references.

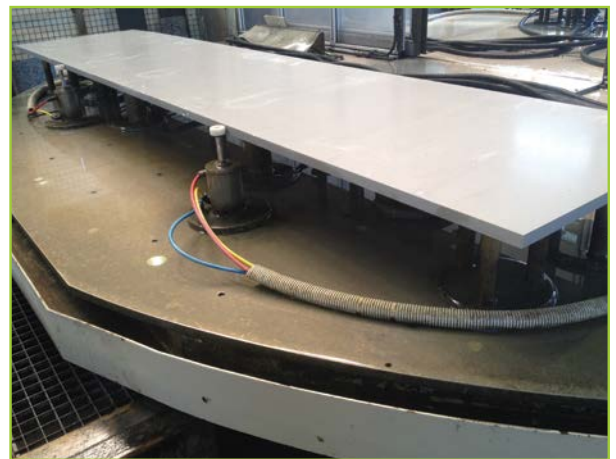
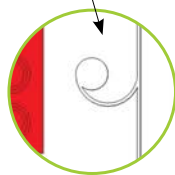
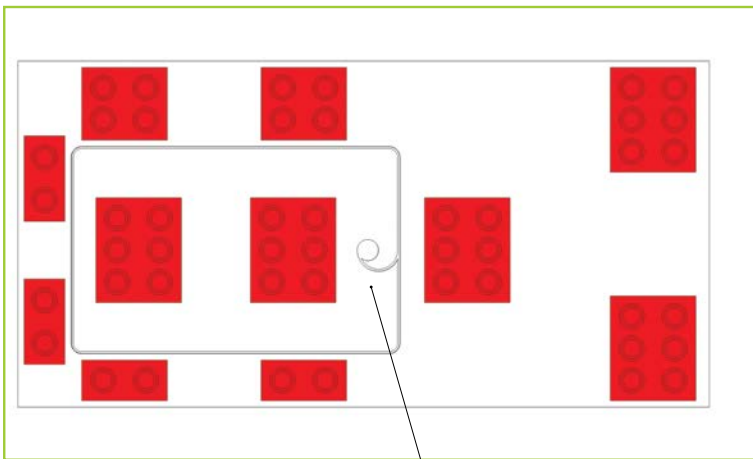

Thicknesses		Feed rate mm/min	Rpm/min	Maximum removal
¼", ½" and ¾"	1 3/8" core drill tool	15-20	4000/5000	-
	Cutting tool (finger bit) through solid Diam. 19-22 mm.	300-350	4000/5000	-
	Flush countertop tool Diam. 15 mm (or incremental cutting milling tool).	350	5000/6000	3mm/pass

## FABRICATION

### Finishing of the edges and exposed chamfers

The exposed edges should be rounded in order to obtain a chamfer of about 1/8" wide, whether monolithic execution (1/2" and 3/4") or a surface with mitered edge. Polishing the exposed edges (1/2" and 3/4") can be carried out using descending-grid diamond tools. Remember to treat the exposed surface of the edge with oil and water repellent products after execution.

Products suitable for this use are sold, for example, by Tenax, Faber Chimica or Fila.

### WORKED EDGES



#### 45 DEGREES MITERED EDGE

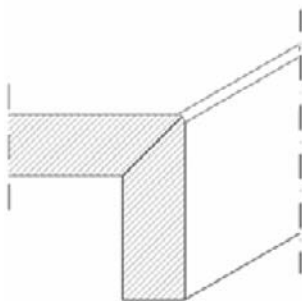

1. Cut the edges of both pieces at an angle
2. Clean all the edges
3. Use epoxy resin to glue the two pieces together
4. The resin must be the same colour as the slab
5. Remove residues of resin

#### BEVELLED EDGE

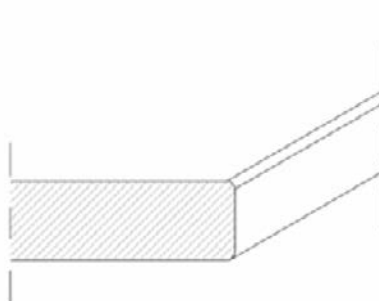

- A bevelled edge is useful for increasing the ability of the edge of the slab to resist strong shocks
1. Use sandpaper appropriate for porcelain slabs
  2. Use abrasives in the correct order to obtain the desired finish

#### BULLNOSE EDGE

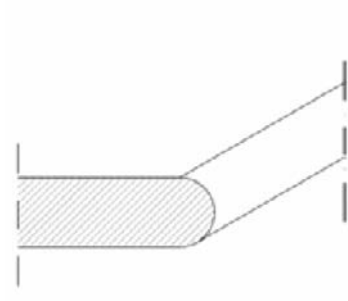

- The bullnose edge is also useful for increasing the resistance of the slab edge to strong shocks
1. Use sandpaper appropriate for porcelain stoneware
  2. Use abrasives in the correct order to obtain the desired finish

## FABRICATION

Use abrasives in the correct order to obtain the desired finish.

### Approximate parameters:

Abrasive: Satin finish 120-220-500

Abrasive: Glossy finish 100-200-500-1000-2000

Brush Sequence: 36-46-80-120-(220-400)

Speed: 36 to 48 inch/min.

Remember to make the edge with at least a 1/16" bevel, round, or diagonal, to prevent the chipping of the edge.

## EDGE POLISHING

Indicative sequence of the abrasives to be used for the finishing of the edge

(Both for machining with edge polisher – feed rate 25 to 30 inch/min, and for manual machining)

	grid
Glossy surface	1. GR 50
	2. GR 100
	3. GR 200
	4. GR 500
	5. GR 1000
	6. GR 2000
Matte surface	1. GR 120
	2. GR 220
	3. GR 500

## INSTALLATION

Arrange the structure of the cabinets being covered so that it is level, stable, clean and suitable to receive the weight of the countertop.

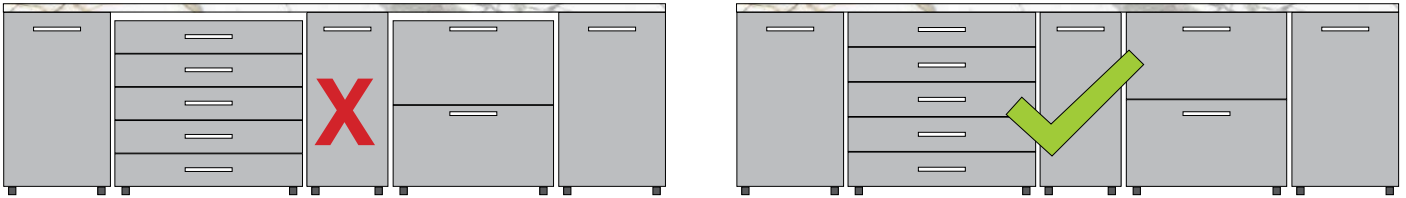

Stiffening joists must be provided transversally at no more than 24" for the 1/2" material, 36" for the 3/4" material.

The countertop must rest, without bending, on each joist and lateral structures.

Transport of the countertop must include preparation of adequate packaging (crate) in which to arrange the countertop vertically.

On the job site, the slabs must be handled vertically in order to avoid bending.

Secure the countertop to the structure using a continuous bead of silicone.

**Note:** the structure of the furniture must be checked periodically in terms of levelling, compensating for any misalignments.

## TOOLS / MATERIALS

### Products for structural gluing

To join ceramic elements (e.g. straight edge) use two-component epoxy or polyurethane resins of the same colour as the material, taking care to avoid the formation of gaps.

After the pairing and before the resin sets, eliminate any trace of excess resin.

Grind the edge to obtain a chamfer at least 1/16" wide.

To glue the countertop to the structure and/or to seam 2 pieces, we recommend using an elastic and transparent adhesive (e.g. silicone).

To fill the coupling joints between the flush-mount element and the slab (when applicable) use an elastic and transparent adhesive (e.g. silicone) or plastic gaskets supplied by the manufacturer of the appliance/sink.

## CARE AND MAINTENANCE

### Routine maintenance

For daily cleaning, a damp microfiber cloth is enough. For regular cleaning, we suggest using a neutral liquid detergent with a soft sponge or a microfiber cloth.

### Persistent stains

Persistent stains can be removed with a slightly abrasive sponge; if necessary, use a specially formulated stain remover (see table). Do not use steel wool pads, because these would leave metal traces that would then have to be cleaned again.

### Precautions

Remove any spills of staining liquids (like coffee, tea, red wine), caustic substances (such as oven cleaner), acids and colorants as soon as possible and rinse with water. **FLORIM stone** surfaces are particularly resistant to thermal shocks. You can place hot pans directly on the surface, however we recommend the use of trivets to protect the surface over time. Ceramic knives can damage the surface; therefore, we recommend to use cutting boards. Avoid hitting the most delicate parts of the surface, such as its corners and edges.

Type of dirt	Natural surface detergent	Polished surface detergent
Traces of metal	neutral/acid detergent	neutral/acid detergent
Cola	neutral detergent	neutral detergent
Lemon	neutral detergent	neutral detergent
Coffee/tea	neutral detergent	neutral detergent/bleach
Wine	neutral detergent	neutral detergent/bleach
Sauces/Ketchup	neutral detergent, cream or powder detergent	neutral detergent, cream or powder detergent
Fat	neutral/alkaline detergent	neutral/alkaline detergent
Oil	neutral detergent	neutral detergent
Scale/Rust	Acid detergent	neutral/acid detergent
Fruit juice	neutral detergent	neutral detergent/bleach
Ice Cream	neutral detergent	neutral detergent/bleach
Resin	solvent	solvent
Permanent marker	cream or powder detergent	neutral detergent/bleach
Vinegar	neutral detergent	neutral detergent/bleach

### Legend:

- alkaline detergent: degreasing agents in general, ammoniac.
- acid detergent: descaler, pickling agent for removing cement residue.
- solvents: white spirit, nitro diluent, alcohol, acetone and similar products.
- cream or powder detergent: products for cleaning hard surfaces.
- neutral detergent: generic pH-neutral cleaning product.

### Caution:

observe the detergent manufacturer's precautions and recommended dilutions.  
Do not use products containing hydrofluoric acid or its derivatives.

## GOOD WORKING PRACTICES

Nowadays, there is a growing attention to health and the need to reduce potential risks stemming from work activities. In the construction field and in the natural and synthetic stone processing industry, this attention is also focused on the reduction of lung diseases caused by dust, with the presence of breathable free crystalline silica being recognised as potentially hazardous to personnel in the work environment.

Silica is the primary ingredient in ceramic body, in addition to representing about half the weight of the earth's crust since it is present in sand, granite and many other minerals.

The fraction potentially dangerous to human health is only free crystalline silica in its breathable fraction, characterised by a precise grain size.

**FLORIM** ceramic tiles and slabs consist of a body made up of natural raw materials (clay, feldspar, kaolin, sand), therefore containing both amorphous and crystalline silica. Since these components are stably absorbed inside the ceramic compound, there are no problems of toxicity, nor are there any formal labelling obligations.

Breathable free crystalline silica in its "breathable" fraction forms with the subsequent processes (cutting, polishing, shaping, grinding, perforation, etc.) and, in the absence of appropriate precautions, can penetrate deep into the lungs, causing, for high exposure (in other words, prolonged and repeated exposure over the years combined with high concentrations) irreversible effects on the health (pneumoconiosis as well as silicosis) or the worsening of lung diseases.

### Precautions for safe handling

Remember to assess the weight of the material and procure systems for adequate and certified handling for the load being moved.

For the handling of **FLORIM stone** slabs, no particular precautions are required, except for the normal personal protective equipment in use for work activities (cut-resistant gloves, safety shoes) based on prevailing regulations.

For the manipulation of large pieces, we recommend also using cut-resistant sleeves for forearm protection.

**FLORIM stone** slabs are obtained by coupling a ceramic slab with fibreglass and polyurethane resin.

In addition to the aforementioned personal protective equipment, for handling, wear eye protection and a dust mask to avoid direct contact of the skin and mucous membranes with the fibreglass.

Should the material be supplied on stands, pay particular attention to the safety of the system: check the integrity of the packaging and its stability before beginning any operation in order to prevent the danger of crushing due to the load tipping over.

Always secure the load in the event of partial retrieval from the stand.

### Precautions for safe processing

Professional installers and processors, since they are experts in the sector, should already be aware of the potential health risks stemming from the inhalation of dust deriving from working with ceramic tiles (cutting, buffing, etc.).

They are urged to apply the local prevailing laws/rules/directives, adequately instructing the employees on the potential hazards, on the adoption of personal hygiene measures in the workplace (e.g. not eating, drinking or smoking during the processes, carefully washing and changing clothes after work, etc.), on the use of suitable equipment (e.g. privileging wet cutting and grinding tools or dry cutting tools connected to properly working vacuum systems, etc.) and personal protective systems (e.g. protective gloves, FFP3 dust masks for protection of the respiratory system, safety eye protection, etc.).

We recommend reading the most updated information on dedicated websites, usually managed by government bodies, for occupational safety.

(<https://www.nepsi.eu/>)





**TECHNICAL FEATURES**

**FLORIM**  
stone ■ 612 20

## FLORIM stone - Thickness 6,7 mm 1/4" with mat back

Porcelain tile with glass fibre mat backing  
Ceramic panel thickness 6 mm - panel with mat back thickness 6.7 mm

Non-rectified format **163x324 cm - Guaranteed working size 160x320 cm				
FLORIM stone with mat backing is obtained by coupling a non-rectified panel of porcelain tile to a glass fibre mat; find herebelow the porcelain tile requirements.				
TECHNICAL FEATURES	REFERENCE STANDARD	STANDARD REQUIREMENTS		TEST RESULTS
		(%)	(mm)	
ADMITTED DEVIATION, IN %, OF THE AVERAGE THICKNESS OF EACH TILE FROM THE PRODUCTION DIMENSIONS	ISO 10545-2	±5%		±5%
FLATNESS (CURVING IN THE MIDDLE, CORNER AND WARPING)	ISO 10545-2	±0,5% ±2mm		±0,35% ±2mm*
SURFACE QUALITY	ISO 10545-2	At least 95% of the tiles must be free from visible flaws.		CONFORMING
% WATER ABSORPTION	ISO 10545-3	< 0,5%		Average value 0,08%
RESISTANCE TO DEEP ABRASION OF UNGLAZED TILES	ISO 10545-6	< 175mm <sup>3</sup>		Average value 140mm <sup>3</sup>
THERMAL SHOCKS RESISTANT	ISO 10545-9	Available testing method		RÉSISTANT
RESISTANCE TO STAINING	ISO 10545-14	SEE MANUFACTURER'S DECLARATION		Classe 5 (Matte/Velvet) Classe 3-4 (Glossy)
RESISTANCE TO LOW CONCENTRATIONS OF ACIDS AND ALKALIS.	ISO 10545-13	SEE MANUFACTURER'S DECLARATION		ULA-ULB (Matte/Velvet) ULB (Glossy)
RESISTENCE TO DOMESTIC CHEMICAL PRODUCTS AND ADDITIVES FOR SWIMMING POOLS		MIN B		UA
FROST RESISTANCE	ISO 10545-12	REQUIRED		RÉSISTANT
MOISTURE EXPANSION	ISO 10545-10	Declared value		0,01% (0,1mm)

\*\* Length and width, orthogonality and straightness are not applicable since the material is NOT rectified.

\* Data refers to the material after squaring

**FLORIM stone - Thickness 6,7 mm 1/4" with mat back**

Porcelain tile with glass fibre mat backing  
Ceramic panel thickness 6 mm - panel with mat back thickness 6.7 mm

The coupling process improves the panel's mechanical properties. Since no applicable standard exists, Florim has run tests to demonstrate the results.

Mat-mounted porcelain stoneware			
TECHNICAL FEATURES			
FEATURE	REFERENCE STANDARD	DESCRIPTION OF TEST METHOD	TEST RESULTS N ≥ 15 cm
BREAKING STRENGTH IN N (thickness < 7,5 mm)	ISO 10545-4	Application of a load to the midline of the panel until failure is obtained	Average value 1556 N*
N/mm <sup>2</sup> FLEXURAL STRENGTH TEST			Average value 54,5 N/mm <sup>2</sup> *
FIRE - RESISTANCE	UNI EN 13501-1	Floor radiant panel test UNI EN ISO 9293-1.	Classe B <sub>FL</sub> - s1, d0
IMPACT RESISTANCE	UNI EN ISO 14617-9	Resistance to dropping a 1 kg steel ball on a sample placed on a bed of sand.	Average value 3,16 J
COEFFICIENT OF RETURN	UNI EN ISO 10545-5	Measurement of 28 g steel ball rebound height.	Average value 0,88 no surface damage.
VOLATILE ORGANIC COMPOUND EMISSION TESTS.	UNI EN ISO 16000-9	VOC emission after 28 days length - test	Classe A+
COMPRESSION STRENGTH	ASTM C170M-16	Breaking load on 12x12x12 mm samples.	Tensile strength 527,9 Mpa sample deformation 0,86 mm.

\*Measurements made on 60x60 cm size

## FLORIM stone - Thickness 6,7 mm 1/4" with mat back

Porcelain tile with glass fibre mat backing  
Ceramic panel thickness 6 mm - panel with mat back thickness 6.7 mm

FLORIM stone with mat backing special technology and aesthetic versatility make the material ideal for both furnishing and kitchen tops. We list the results below.

Results on surface			
TECHNICAL FEATURES			
FEATURE	REFERENCE STANDARD	DESCRIPTION OF TEST METHOD	TEST RESULTS N ≥ 15 cm
Release of hazardous substances	ISO 10545-15	Declared value for GL surfaces used on worktops	COMPLIANT
Resistance to damp heat	UNI EN 12721:2013	55° to 100° cycles	No visible change CEN TS 16209 Class A.
Resistance to dry heat	UNI EN 12722:2013	55° to 180° cycles	No visible change CEN TS 16209 Class A.
Resistance to cold liquids	UNI EN 12720:2013	Period of contact 10s to 24 h	CEN TS 16209 Classe B
Tendency to retain dirt	UNI 9300:2015	Carbon black staining agent	No visible change
Scratch resistance	UNI EN 15186:2012 met.B	Load > 10 N (Naturale/Matte) Load > 8 N (Velvet) Load > 3,7 N (Glossy)	Classe A
Fungi resistance	ASTM G 21-15	Contact for 28 days with a variety of fungi strains	No growth on the surface
Solar Reflectance Index SRI Light Reflectance Value LRV	In-house test method.	spettrofotometro a 10°/ Spectrophotometer at 10°	Based on the colour: Available on request
Colours' resistance to light fading	DIN 51094	Evaluation of the color changes following a 28 day exposure to ultra violet light.	COMPLIANT
Friction coefficient (slipperiness)	DCOF (section 9.6 ANSI A 1371.2012)	> 0,42 wet	> 0,42 wet (naturale/matte)

**FLORIM stone - Thickness 12,7 mm 1/2" with mat back**

Porcelain tile with glass fibre mat backing  
Ceramic panel thickness 12 mm - panel with mat back thickness 12.7 mm

Non-rectified format **163x324 cm / Guaranteed working size 160x320 cm				
FLORIM stone with mat backing is obtained by coupling a non-rectified panel of porcelain tile to a glass fibre mat; herebelow the requirements for porcelain tile.				
TECHNICAL FEATURES	REFERENCE STANDARD	STANDARD REQUIREMENTS		TEST RESULTS
		(%)	(mm)	
ADMITTED DEVIATION, IN %, OF THE AVERAGE THICKNESS OF EACH TILE FROM THE PRODUCTION DIMENSIONS	ISO 10545-2	±5%		±5%
FLATNESS (CURVING IN THE MIDDLE, CORNER AND WARPING)	ISO 10545-2	±0,5% ±2 mm		±0,35% ±2mm*
SURFACE QUALITY	ISO 10545-2	At least 95% of the tiles must be free from visible flaws.		COMPLIANT
% WATER ABSORPTION	ISO 10545-3	< 0,5%		Average value 0,08%
RESISTANCE TO DEEP ABRASION OF UNGLAZED TILES	ISO 10545-6	< 175mm <sup>3</sup>		Average value 140mm <sup>3</sup>
THERMAL SHOCKS RESISTANT	ISO 10545-9	Available testing method		RÉSISTANT
RESISTANCE TO STAINING	ISO 10545-14	SEE MANUFACTURER'S CERTIFICATE		Classe 5 (Matte/Velvet) Classe 3-4 (Glossy)
RESISTANCE TO LOW CONCENTRATIONS OF ACIDS AND ALKALIS.	ISO 10545-13	SEE MANUFACTURER'S CERTIFICATE		ULA-ULB (Matte/Velvet) ULB (Glossy)
RESISTENCE TO DOMESTIC CHEMICAL PRODUCTS AND ADDITIVES FOR SWIMMING POOLS		MIN B		UA
FROST RESISTANCE	ISO 10545-12	REQUIRED		RÉSISTANT
MOISTURE EXPANSION	ISO 10545-10	Declared value		0,01% (0,1mm)

\*\* Length and width, orthogonality and straightness are not applicable since the material is NOT rectified.

\* Data refers to the material after squaring

## FLORIM stone - Thickness 12,7 mm 1/2" with mat back

Porcelain tile with glass fibre mat backing  
Ceramic panel thickness 12 mm - panel with mat back thickness 12.7 mm

The coupling process improves the panel's mechanical properties. Since no applicable standard exists, Florim has run tests to demonstrate the results.

<b>Mat-mounted porcelain stoneware</b>			
<b>Mechanical results</b>			
TECHNICAL FEATURES			
FEATURE	REFERENCE STANDARD	DESCRIPTION OF TEST METHOD	TEST RESULTS N ≥ 15 cm
BREAKING STRENGTH IN N (thickness > 7,5 mm)	ISO 10545-4	Application of a load to the midline of the panel until breakage is obtained	Average value 5500 N*
N/mm <sup>2</sup> FLEXURAL STRENGTH TEST			Average value 53 N/mm <sup>2</sup> *
FIRE REACTION	UNI EN 13501-1	Floor radiant panel test UNI EN ISO 9293-1.	Classe B <sub>FL</sub> - s1, d0
IMPACT RESISTANCE	UNI EN ISO 14617-9	Resistance to dropping a 1 kg steel ball on a sample placed on a bed of sand.	Average value 3,03 J
COEFFICIENT OF RETURN	UNI EN ISO 10545-5	Measurement of 28 g steel ball rebound height.	Average value 0,91 no surface damage.
VOLATILE ORGANIC COMPOUND EMISSION TESTS.	UNI EN ISO 16000-9	28 days length-test	Classe A+
COMPRESSION STRENGTH	ASTM C170M-16	Breaking load on 12x12x12 mm samples.	Breaking tension 527,9 Mpa sample deformation 0,86 mm.
STATIC LOAD FOR RAISED FLOORS.	UNI EN ISO 12825	Application of increasing load until sample until breakage is obtained.	average values* lateral midpoint: 1,925 kN centre: 3,545 kN

\*Measurements made on a 25x50 cm size

**FLORIM stone - Thickness 12,7 mm 1/2" with mat back**

FLORIM stone with mat backing special technology and aesthetic versatility, make the material ideal for both furnishing and kitchen tops. We list the results below

<b>Results on surface</b>			
TECHNICAL FEATURES			
FEATURE	REFERENCE STANDARD	DESCRIPTION OF TEST METHOD	TEST RESULTS N ≥ 15 cm
Release of hazardous substances	ISO 10545-15	Declared value for GL surfaces used on worktops	COMPLIANT
Resistance to damp heat	UNI EN 12721:2013	55° to 100° cycles	Nessun cambiamento visibile CEN TS 16209 Classe A No visible change CEN TS 16209 Class A.
Resistance to dry heat	UNI EN 12722:2013	55° to 180° cycles	Nessun cambiamento visibile CEN TS 16209 Classe A No visible change CEN TS 16209 Class A.
Resistance to cold liquids	UNI EN 12720:2013	Period of contact 10s to 24 h	Nessun cambiamento visibile CEN TS 16209 Classe B No visible change CEN TS 16209 Class B.
Tendency to retain dirt	UNI 9300:2015	Carbon black staining agent	Nessun cambiamento visibile No visible change
Scratch resistance	UNI EN 15186:2012 met.B	Load > 10 N (Naturale/Matte) Load > 8 N (Velvet) Load > 3,7 N (Glossy)	Classe A
Fungi resistance	ASTM G 21-15	Contact for 28 days with a variety of fungal strains	Nessuna crescita fungina in superficie No fungi growth on the surface
Solar Reflectance Index SRI Light Reflectance Value LRV	In-house test method.	Illuminant D65 Spectrophotometer at 10°	Based on the colour: Available on request
Colours' resistance to fading	DIN 51094	Evaluation of the color changes following a 28 day exposure to ultra violet light.	COMPLIANT
Friction coefficient (slipperiness)	DCOF (section 9.6 ANSI A 1371.2012)	> 0,42 wet	> 0,42 wet (naturale/matte)

## FLORIM stone - Thickness 20mm 3/4"

FINE PORCELAIN STONWARE

Non-rectified format **163x324 cm / Guaranteed working size 160x320 cm				
TECHNICAL FEATURES				
Un glazed porcelain stoneware slabs. Dry-pressed ceramic tiles. Quality specifications, according to control tests of E.N. 14411. Appendix G group B1a UGL.	REFERENCE STANDARD	STANDARD REQUIREMENTS		TEST RESULTS
		N ≥ 15 cm		
		(%)	(mm)	
ADMITTED DEVIATION, IN %, OF THE AVERAGE THICKNESS OF EACH TILE FROM THE PRODUCTION DIMENSIONS	ISO 10545-2	±5%		±5%
FLATNESS (CURVING IN THE MIDDLE, CORNER AND WARPING)	ISO 10545-2	±0,5% ±2 mm		±0,35% ±2mm*
SURFACE QUALITY	ISO 10545-2	At least 95% of the tiles must be free from visible flaws.		CONFORMING
% WATER ABSORPTION	ISO 10545-3	< 0,5%		Average value 0,08%
BREAKING STRENGTH IN N (thickness > 7,5 mm)	ISO 10545-4	1300 min		Average value 14000Newton***
N/mm <sup>2</sup> FLEXURAL STRENGTH TEST		> 35 N/mm <sup>2</sup>		Average value 52 N/mm <sup>2</sup> ***
RESISTANCE TO DEEP ABRASION OF UNGLAZED TILES	ISO 10545-6	< 175mm <sup>3</sup>		Average value 140mm <sup>3</sup>
THERMAL SHOCKS RESISTANT	ISO 10545-9	Available testing method		RÉSISTANT
RESISTANCE TO STAINING	ISO 10545-14	SEE MANUFACTURER'S CERTIFICATE		Classe 5 (Matte/Velvet) Classe 3-4 (Glossy)
RESISTANCE TO LOW CONCENTRATIONS OF ACIDS AND ALKALIS.	ISO 10545-13	SEE MANUFACTURER'S CERTIFICATE		ULA (Matte/Velvet) ULB (Glossy)
RESISTANCE TO DOMESTIC CHEMICAL PRODUCTS AND ADDITIVES FOR SWIMMING POOLS		MIN B		UA
FROST RESISTANCE	ISO 10545-12	REQUIRED		RÉSISTANT
MOISTURE EXPANSION	ISO 10545-10	Declared value		0,01% (0,1mm)
FIRE REACTION	UNI EN 13501-1	Decision 96/603/EC and amendments		Classe A1 - A1 fl

\*\*\*Measurements made on 60x60 cm size

\*\* Length and width, orthogonality and straightness are not applicable since the material is NOT rectified.

\* Data refers to the material after squaring



**FLORIM stone - Thickness 20mm 3/4"**

FINE PORCELAIN STONEWARE

	REFERENCE STANDARD	DESCRIPTION OF TEST METHOD	TEST RESULTS
VOLATILE ORGANIC COMPOUND EMISSION TESTS.	UNI EN ISO 16000-9	Test running on a 28 day length	Classe A+
COMPRESSION STRENGTH	ASTM C170M-16	Breaking load on 12x12x12 mm samples	Breaking tension 527.9 Mpa sample deformation 0.86 mm.
STATIC LOAD FOR RAISED FLOORS.	UNI EN ISO 12825	Application of increasing load until sample until breakage is obtained.	average values*** lateral midpoint: 7,21 kN centre: 8,69 kN

FLORIM stone's special technology and aesthetic versatility make the material ideal both for furnishing and kitchen tops. We list the results below.

Results on surface			
TECHNICAL FEATURES			
FEATURE	REFERENCE STANDARD	DESCRIZIONE DEL METODO DI PROVA DESCRIPTION OF TEST METHOD	TEST RESULTS N = 15 cm
Release of hazardous substances	ISO 10545-15	Declared value for GL surfaces used on worktops	COMPLIANT
Resistance to damp heat	UNI EN 12721:2013	55° to 100° cycles	No visible change CEN TS 16209 Class A.
Resistance to dry heat	UNI EN 12722:2013	55° to 180° cycles	No visible change CEN TS 16209 Class A.
Resistance to cold liquids	UNI EN 12720:2013	Period of contact 10s to 24 h	CEN TS 16209 Class B
Tendency to retain dirt	UNI 9300:2015	Carbon black staining agent	No visible change
Scratch resistance	UNI EN 15186:2012 met.B	Load > 10 N (Naturale/Matte) Load > 8 N (Velvet) Load > 3,7 N (Glossy)	Classe A
Fungi resistance	ASTM G 21-15	Contact for 28 days with a variety of fungi strains	Nessuna crescita fungina in superficie No fungi growth on the surface
Solar Reflectance Index SRI Light Reflectance Value LRV	In-house test method.	Illuminant D65 Spectrophotometer at 10°	Based on colour: Available on request
Colours' resistance light	DIN 51094	Evaluation of the color change following a 28 day exposure to ultra violet rays.	COMPLIANT
Friction coefficient (slipperiness)	DCOF (section 9.6 ANSI A 1371.2012)	> 0,42 wet	> 0,42 wet (naturale/matte)

# FLORIM

stone  6 12 20

Florim Ceramiche S.p.A.  
Via Canaletto, 24  
41042 Fiorano Modenese (MO)  
Tel. +39 0536 840111 / Fax +39 0536 844750  
[www.florimstone.com](http://www.florimstone.com)  
[www.florim.com](http://www.florim.com)