

KLIFE

MADE IN ITALY. MADE TO EXCEL.



 atlas concorde



Atlas Concorde is a global specialist in premium porcelain and wall tiles for every style and application in residential, commercial and public architecture. Being global specialists means excellence in the level of design and technology in each type of surface, making it possible to always offer designers and end users the best solution for each application.

Atlas Concorde è specialista globale in superfici ceramiche d'eccellenza per ogni stile e applicazione nell'architettura residenziale, commerciale e pubblica. Essere specialisti globali significa eccellere per livello di design e tecnologia in ciascun tipo di superficie, così da offrire sempre ai progettisti e agli utilizzatori finali la soluzione migliore per ogni applicazione.

STONE LOOK

COLOURED BODY
PORCELAIN TILES
GRES PORCELLANATO
COLORATO IN MASSA
Gres porcelánico
coloreado en masa
Durchgefärbtes
Feinsteinzeug
Grès cérame coloré
dans la masse
Керамический гранит
окрашенный в массе

WHITE-BODY
WALL TILES
RIVESTIMENTI
IN PASTA BIANCA
Revestimientos
en pasta blanca
Weißscherbige
Wandfliesen
Revêtements
en pâte blanche
Настенная плитка
из белой глины



KLIF

THE PUREST EXPRESSION OF MATTER

atlasconcorde

PURE STRENGTH

FORWARD TO / THE ORIGINS



—ES La elegancia refinada de la piedra toma vida en una colección inspirada en la beola de la Val d'Ossola. Las superficies cobran protagonismo en los ambientes cargados de potente fuerza visual, en los que nos reconocemos así mismo.

—FR La grande élégance de la pierre est revisitée dans une collection qui s'inspire de la beola du Val d'Ossola. Placées au centre de la scène, ces surfaces deviennent les protagonistes d'espaces de grande force visuelle qui mettent chacun à l'aise.

—DE Die charaktervolle Eleganz des Natursteins lebt in einer Kollektion wieder auf, die den Beola-Stein aus dem Ossolatal nachempfunden hat. Die ganz in den Mittelpunkt des Geschehens gerückten Oberflächen lassen Räume von großer visueller Kraft entstehen, in denen man sich gerne wiedererkennt.

—PY Строгая элегантность камня возрождается в коллекции, вдохновленной гнейсом Веола долины Вал д'Оссола. Выразительная поверхность плит становится эффектной доминантой пространств, отражающих наш характер.



The decisive elegance of stone comes to life in a collection inspired by beola stone of Val d'Ossola. Placed in the center of the environment, the surfaces become the focus with a great visual power that reflects your tastes.

L'eleganza decisa della pietra rivive in una collezione ispirata alla beola della Val d'Ossola. Messe al centro della scena, le superfici diventano protagoniste di ambienti dalla grande forza visiva, in cui è bello riconoscersi.



POWERFUL ELEGANCE



Contemporary architecture takes its inspiration from nature and goes further, making it the focal point of the spaces. Klif reinterprets the decisive elegance of stone to give life to spaces of solid expressiveness, where you can feel in harmony with the environment.

L'architettura contemporanea prende ispirazione dalla natura e si spinge oltre, fino a renderla protagonista degli ambienti. Klif reinterpreta l'eleganza decisa della pietra per dare vita a spazi dalla solida espressività, dove sentirsi in armonia con l'ambiente.

—ES La arquitectura contemporánea se inspira en la naturaleza llegando a convertirla en protagonista de los ambientes. Klif reinterpreta la elegancia decidida de la piedra dando vida a espacios de fuerte expresividad, haciéndonos sentir parte del entorno que nos rodea.

—FR L'architecture contemporaine puise son inspiration dans la nature, et va bien au-delà, elle la rend protagoniste de l'espace. Klif réinterprète la grande élégance de la pierre pour donner naissance à des espaces de grande expressivité où se sentir en parfaite harmonie.

—DE Die zeitgenössische Architektur inspiriert sich an der Natur und geht noch weiter: sie rückt sie ganz in den Vordergrund des Raums. Klif ist eine neue Interpretation der charaktervollen Eleganz dieses Natursteins und lässt Räume mit solider Ausdruckskraft entstehen, in denen die Harmonie mit der Umwelt spürbar ist.

—PY Современная архитектура не просто черпает вдохновение в природе, а превращает ее в главный элемент обстановки. Klif по-новому интерпретирует строгую элегантность камня, создавая выразительные, пронизанные гармонией пространства.



DELICATE STRENGTH



Realism is one of the strong points of the surface, which faithfully reproduces the veins and shading typical of beola stone. Surface roughness and quartz crystals create the same sparkling effects as natural stone.

Il realismo è uno dei punti di forza della superficie, che riproduce fedelmente le venature e le sfumature tipiche della beola. Asperità superficiali e cristalli di quarzo creano gli stessi effetti di riflessione luminosa della pietra naturale.

DESIGNED / BY NATURE



—ES Uno de los puntos fuertes de la superficie es el realismo ya que reproduce fielmente las vetas y los matices típicos de la beola. Asperezas superficiales y cristales de cuarzo crean los mismos reflejos de luz de la piedra natural.

—FR Le réalisme est un des points forts de cette surface qui reproduit fidèlement les veinures et les tonalités typiques de la beola. Les aspérités superficiales et les cristaux de quartz créent les mêmes reflets lumineux de la pierre naturelle.

—DE Beeindruckender Realismus ist eine der starken Seiten der Oberfläche, die die für den Beola typischen Äderungen und Nuancen getreu wiedergibt. Oberflächige Unebenheiten und Kristallquarze erzeugen die gleichen Lichtreflexe wie der Naturstein.

—PY Реализм – одна из главных характеристик коллекции, которая с точностью воспроизводит прожилки и цветовые оттенки камня Beola. Шероховатость поверхности и кварцевые кристаллы рождают такое же свечение, как на исходном природном камне.



atlas concorde



atlas concorde

—ES En los espacios más escenográficos de la arquitectura contemporánea, la superficie matérica de efecto piedra crea un fondo lleno de atmósfera, diseñado para acoger tu propio estilo. La belleza se convierte en la protagonista absoluta.

—FR Dans les espaces les plus scénographiques de l'architecture contemporaine, la surface effet pierre crée une toile de fond remplie d'atmosphère, dessinée à votre image. La beauté devient la protagoniste absolue.

—DE In den effektivsten Räumen der zeitgenössischen Architektur bildet die stoffliche Oberfläche der Natursteinoptik eine stimmungsvolle Kulisse für Ihren persönlichen Stil. In dem die Schönheit an erster Stelle steht.

—PY В роскошных декорациях современной архитектуры, фактурная поверхность под камень рождает харизматичную атмосферу, созданную, чтобы отражать стиль хозяев. Красота становится центральным элементом обстановки.

In the most spectacular spaces of contemporary architecture, the earthy surface of the stone effect creates a background full of atmosphere designed to accommodate your style. Beauty takes center stage.

Negli spazi più scenografici dell'architettura contemporanea, la superficie materica dell'effetto pietra crea uno sfondo carico di atmosfera, disegnato per accogliere il tuo stile. La bellezza diventa la protagonista assoluta.



atlas concorde





The stone effect expresses the beauty of living in spaces that foster a relationship with the environment, where the dialog between indoors and outdoors is always open.

L'effetto pietra esprime la bellezza di vivere in spazi che privilegiano il rapporto con l'ambiente, in cui il dialogo tra interno ed esterno è sempre aperto.

—ES El efecto piedra ensalza el encanto de vivir plenamente en espacios que privilegian la relación con el entorno, en los que el diálogo entre interior y exterior está siempre abierto.

—FR L'effet pierre exprime la beauté de vivre dans des espaces qui privilégient le rapport avec l'environnement, où le dialogue est toujours ouvert entre l'intérieur et l'extérieur.

—DE Die Natursteinoptik bringt die Schönheit eines Lebens in Räumen zum Ausdruck, die die Beziehung zur Umwelt in den Mittelpunkt stellen. In einem stets offenen Dialog zwischen Innen und Außen.

—РУ Рисунок камня рождает натуральную и приятную для проживания обстановку, в которой внутренние и наружные пространства образуют единое гармоничное целое.





atlasconcorde

In contemporary architecture with rigorous style, the play of contrasts between light and dark surfaces defines architectural volumes and the various functional areas, designing the spaces of your everyday life.

In un'architettura contemporanea dallo stile rigoroso, il gioco di contrasti tra le superfici chiare e scure definisce i volumi architettonici e le diverse aree funzionali, disegnando gli spazi della tua quotidianità.



atlasconcorde

**STRONG AND DELICATE
AT THE SAME TIME**

PORCELAIN TILES /
KLIF Grey 75x150 cm - 29 1/2"x59"
KLIF Dark 75x150 cm - 29 1/2"x59"
KLIF Dark Scalino 75 37,5x75 cm - 14 1/2"x29 1/2"
KLIF Silver Brick 37,5x75 cm - 14 1/2"x29 1/2"
OUTDOOR PAVING
KLIF Silver 20mm 45x90 cm - 17 3/4"x35 1/2"
ARBOR Cognac 18,5x150 cm - 7 1/4"x59"

GENUINE /MPRINTING

—ES En una arquitectura contemporánea de estilo riguroso, el juego de contrastes entre las superficies claras y oscuras definen los volúmenes arquitectónicos y las diferentes áreas funcionales, diseñando las áreas de la vida cotidiana.

—FR Dans une architecture contemporaine au style rigoureux, le jeu de contrastes entre les surfaces claires et foncées définit les volumes architecturaux et les différentes zones fonctionnelles, en dessinant les espaces du quotidien.

—DE In einer zeitgenössischen Architektur mit klaren Linien definiert ein Spiel mit den Kontrasten zwischen hellen und dunklen Oberflächen architektonische Volumen und unterschiedliche Funktionsbereiche, und gliedert so die Räume des täglichen Lebens.

—PY В строгой современной архитектуре игра контрастов светлых и темных поверхностей делит пространства повседневной жизни на разные функциональные зоны.



atlas concorde



atlas concorde

● The surface guarantees high resistance to stains. La superficie garantisce un'elevata resistenza alle macchie.

**KLIF
GREY**

atlas concorde

**Klif's microstructure
reproduces the
look of a split-stone surface
with extreme precision.**

La microstruttura di Klif
permette di riprodurre
con precisione estrema la
superficie a spacco della
pietra di ispirazione.





atlas concorde

TRUE β BEAUTY



The material reproduces the unique characteristics of beola stone with extreme realism: the banded structure, the surface covered by soft veins and the quartz crystals that illuminate the shades of gray.

Il materiale riproduce con estremo realismo le caratteristiche uniche della beola: la struttura lamellare, la superficie percorsa da venature morbide, i cristalli di quarzo che illuminano i toni del grigio.

atlas concorde



atlas concorde

ENRICHING EXCHANGES

Soft color changes provide a counterpoint to the vigorous character of the stone.

The light brings out the shades and earthy nature of the surface.

Morbidi passaggi cromatici fanno da contrappunto al carattere vigoroso della pietra. La luce enfatizza le sfumature e la matericità della superficie.



- Suitable for underfloor heating systems.
Idoneo per sistemi di riscaldamento a pavimento.



The exterior elements inspired by stone recall the look of the interior, creating a continuous dialog between architecture and nature.

Gli elementi per esterni ispirati alla pietra si integrano con l'estetica degli interni, creando un dialogo continuo architettura e natura.

atlas concorde

• Durable over time.
Durevole e inalterabile nel tempo.



atlas concorde

REDEFINING THE /STONE EFFECT

- Frost and thermal shock resistant.
Ingelivo, resistente ad elevate escursioni termiche.



atlas concorde



The 20 mm outdoor pavers have superior technical properties that make it possible to design coordinated interior and exterior spaces that guarantee visual continuity.

I pavimenti per esterni in 20 mm dalle elevate proprietà tecniche permettono di progettare in modo coordinato spazi interni ed esterni di design, garantendo la continuità visiva.

atlas concorde



atlas concorde



atlasconcorde

Thanks to its intensely natural inspiration, the characteristic beauty of beola stone lends itself to wellness and hospitality spaces.

Grazie alla sua ispirazione profondamente naturale, l'estetica fortemente caratterizzata della beola si presta ai luoghi del benessere e dell'ospitalità.



atlasconcorde

**TIMELESS
AMBIENCE**

WALL TILES /
KLIF Silver 40x80 cm - 15⁷/₁₆"x31¹/₂"
KLIF 3D Row Silver 40x80 cm - 15⁷/₁₆"x31¹/₂"
KLIF 3D Silver Corner 1,4x40 cm - 5⁵/₁₆"x15¹/₂"
KLIF Silver Corner 1,4x40 cm - 5⁵/₁₆"x15¹/₂"
KLIF Silver Corner A.E. 1,4x1,4 cm - 5⁵/₁₆"x5⁵/₁₆"
PORCELAIN TILES /
KLIF Silver 75x150 cm - 29¹/₂"x59"
ARBOR Tobacco 18,5x150 cm - 7¹/₄"x59"



atlas concorde

—ES Gracias a la inspiración profundamente natural, la personalidad y fuerza estética que caracteriza la beola, la convierte en la ideal para colocarla en lugares dedicados al bienestar y a la hospitalidad.

—DE Dank seines höchst natürlichen, am Beola-Stein inspirierten Aussehens eignet sich das Produkt für Wellness-Bereiche ebenso wie für das Gastgewerbe.

—FR Grâce à son inspiration profondément naturelle, l'esthétisme fortement caractérisé de la beola se prête facilement aux lieux du bien-être et de l'hospitalité.

—PY Благодаря своей глубокой натуральности, фактура гнейса Beola идеально подходит для велнес-салонов, отелей, кафе.



atlas concorde

ROUGH / ELEGANCE

The rough elegance of the chiseled texture of 3D Wall Row adds three-dimensionality to the sink area, emphasizing the style of the curtain wall.

La ruvida eleganza della texture a effetto scalpello del 3D Wall Row dona tridimensionalità alla zona lavabo, enfatizzando lo stile della cortina muraria.



- The three-dimensional structure of the surface makes the material realistic and natural.
La struttura tridimensionale della superficie rende il materiale realistico e naturale.

atlas concorde

KLIF
WALL TILES
3D ROW
SILVER

The rough expressiveness of hand-chiseled stone is brought to life in a contemporary manner in the texture of 3D Row.

La ruvida espressività della pietra scalpellata a mano rivive in chiave contemporanea nel rilievo 3D Row.





atlas concorde

- **Water resistance makes it ideal for wet areas in wellness centers and spas.**
La resistenza all'acqua lo rende ideale per le zone umide di centri benessere e SPA.



atlas concorde

Klif's earthy porcelain tile surface is the ideal solution for spa environments: on a conceptual level it recalls the beauty of stone, and from a practical point of view it ensures maximum safety.

La superficie materica in gres porcellanato di Klif è la soluzione ideale per l'ambiente spa: a livello concettuale richiama la bellezza della pietra, dal punto di vista funzionale assicura la massima sicurezza.

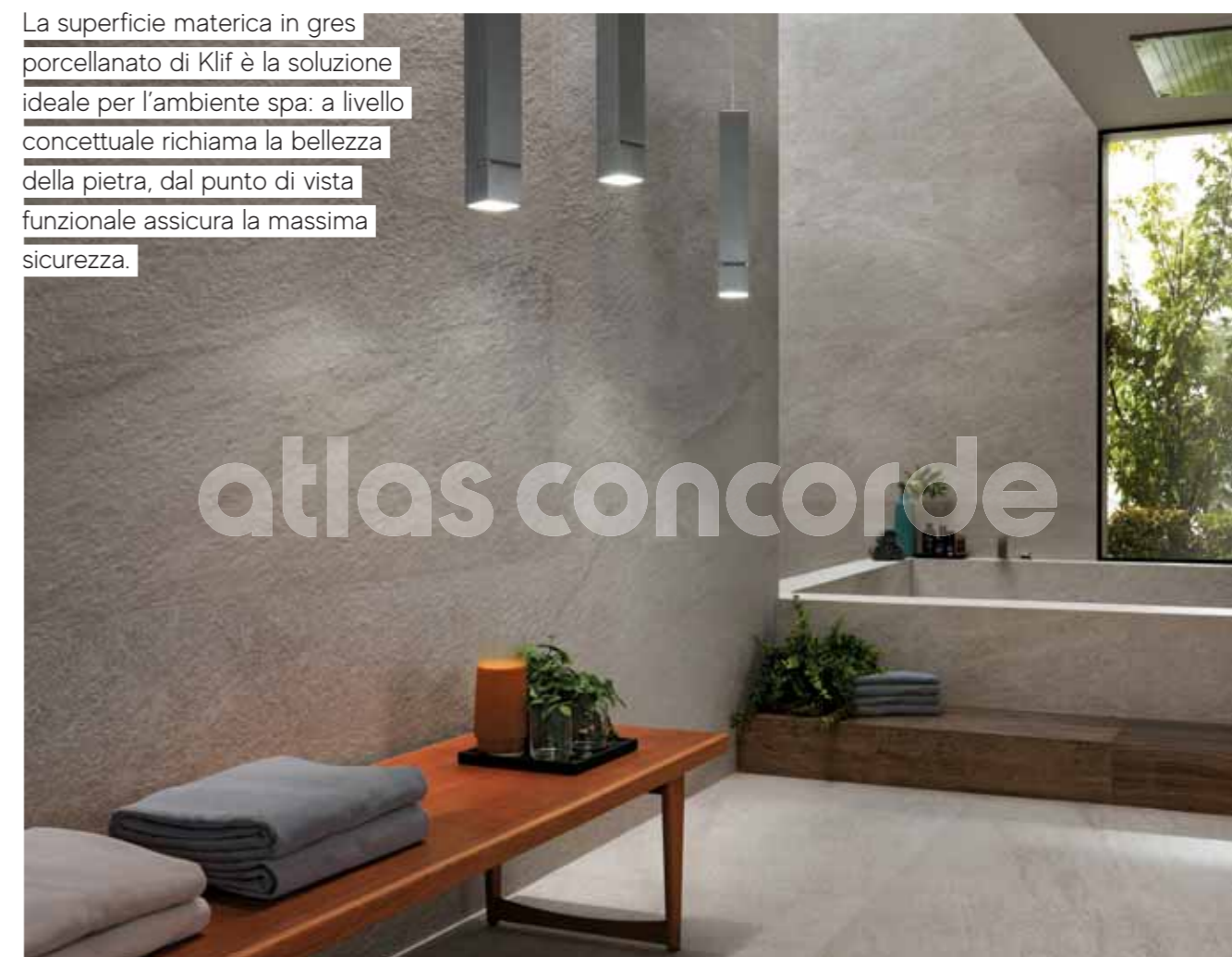

atlas concorde



atlas concorde

**KLIF
SILVER**

The beauty
of split stone is
enhanced by the
great reliability of
porcelain tiles.

L'estetica della
pietra da taglio è
valorizzata dalla
grande affidabilità
del gres porcellanato.



EVERYWHERE / WITH STYLE



The outdoor pavers reflect the unique character and colors of the indoor tiles, creating a visual continuity that provides balance to prestigious architectural solutions.

Le pavimentazioni per esterni ricalcano le peculiarità estetiche e i cromatismi degli interni, creando una continuità visiva che dona equilibrio a soluzioni architettoniche di prestigio.



PORCELAIN TILES /
OUTDOOR PAVING
KLIF Grey 20mm 90x90 cm - 35 / 1 x 35 / 1

BEAUTY AND
PRESTIGE



NO LIMITS / TO DESIGN

—ES Los pavimentos para exteriores reflejan las peculiaridades estéticas y los cromatismos de los interiores, creando una continuidad visual que confiere equilibrio a las soluciones arquitectónicas de prestigio.

—DE Die Bodenbeläge für Außenbereiche weisen die gleichen optischen Besonderheiten und Farbeffekte auf wie jene der Innenräume, so dass optische Kontinuität entsteht. Harmonische Lösungen für prestigevolle Baubjekte.

—FR Les sols d'extérieur reproduisent les particularités esthétiques et les chromatismes des intérieurs, en créant une continuité visuelle qui donne de l'équilibre aux solutions architecturales de prestige.

—PY Уличный керамогранит, перенимая рисунок и цвета у интерьерного, придает всему архитектурному проекту гармоничную цельность и ноту престижа.



DESIGNED FOR OUTDOOR



The 20 mm thick formats and the anti-slip Grip finish make it possible to design environments with total visual continuity between the inside and outside, for a final effect with great impact.

I formati a spessore 20 mm e la finitura antiscivolo Grip permettono di concepire ambienti in totale continuità visiva tra interno ed esterno, per un effetto finale di grande impatto.



- Slip-resistant even when water is present on the surface.
Resistente allo scivolamento anche in presenza di acqua.

PORCELAIN TILES /
KLIF Grey Grip 37,5x75 cm - 14 7/8" x 29 7/8"
OUTDOOR PAVING
KLIF Grey 20mm 45x90 cm - 17 3/4" x 35 3/8"
KLIF Grey 20mm Round 45x90 cm - 17 3/4" x 35 3/8"
KLIF Grey 20mm Round Ang.Sx 45x90 cm - 17 3/4" x 35 3/8"
KLIF Grey 20mm Round Ang.Dx 45x90 cm - 17 3/4" x 35 3/8"
KLIF Grey 20mm Elemento L Angolare 33x33 cm - 13" x 13"
KLIF Grey 20mm Alzata 20x90 cm - 7 7/8" x 35 3/8"

SPECIAL SOLUTIONS / FOR DREAMY SPACES



atlas concorde



atlas concorde

The range includes an array of special pieces for the pool, intended for exclusive architectural projects with a strong visual impact.

La gamma comprende una serie di pezzi speciali per il bordo piscina, destinati a progetti architettonici esclusivi e dal forte impatto scenografico.

FREEDOM / TO CHOOSE

With four shades and seven formats, including the new 90x90 cm with a thickness of 20 mm, the extensive, versatile range offers unlimited design possibilities.

Con quattro tonalità in scala cromatica e sette formati, tra cui il nuovo 90x90 a spessore 20 mm, l'ampia e versatile gamma permette possibilità progettuali senza limiti.

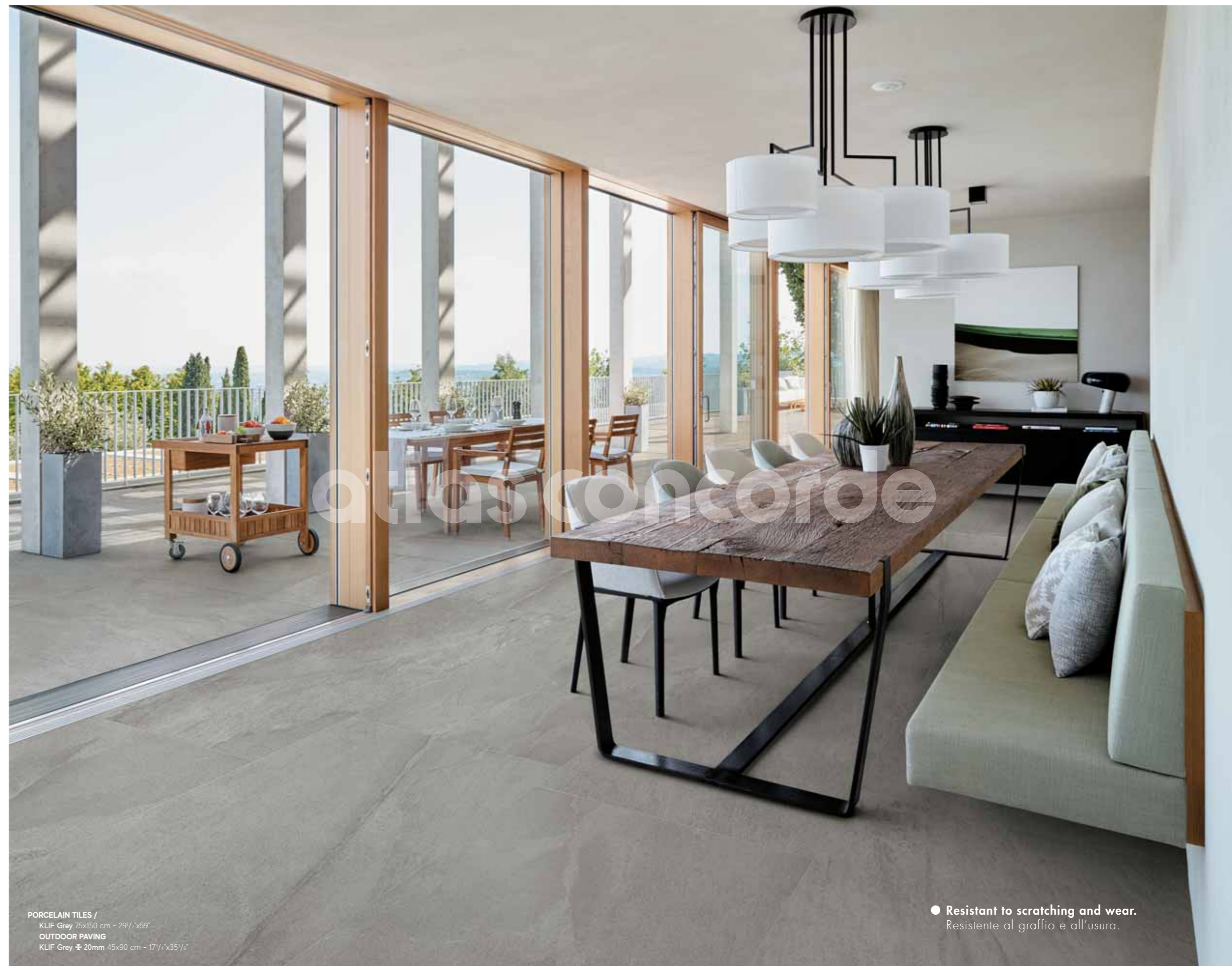

PORCELAIN TILES /
KLIF Grey 75x150 cm - 29 1/2"x59"
OUTDOOR PAVING
KLIF Grey 20mm 45x90 cm - 17 1/4"x35 1/8"

● Resistant to scratching and wear.
Resistente al graffio e all'usura.



A PRESTIGIOUS CHOICE



Combining beauty, practicality, and extreme versatility, the stone-inspired collection opens up new perspectives of design.

Coniugando bellezza, funzionalità ed estrema versatilità della gamma, la collezione ispirata alla pietra apre nuove prospettive alla progettazione.

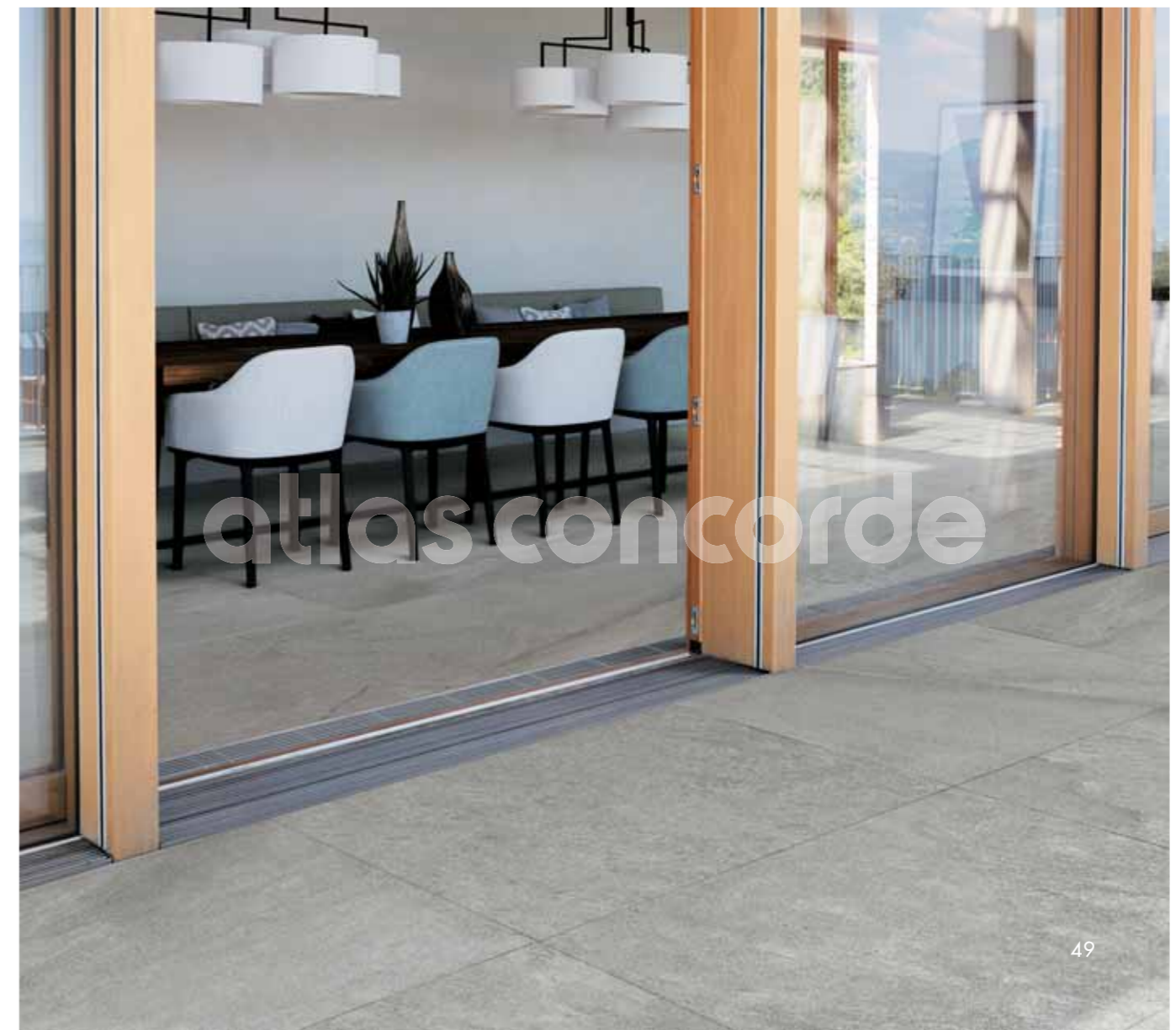

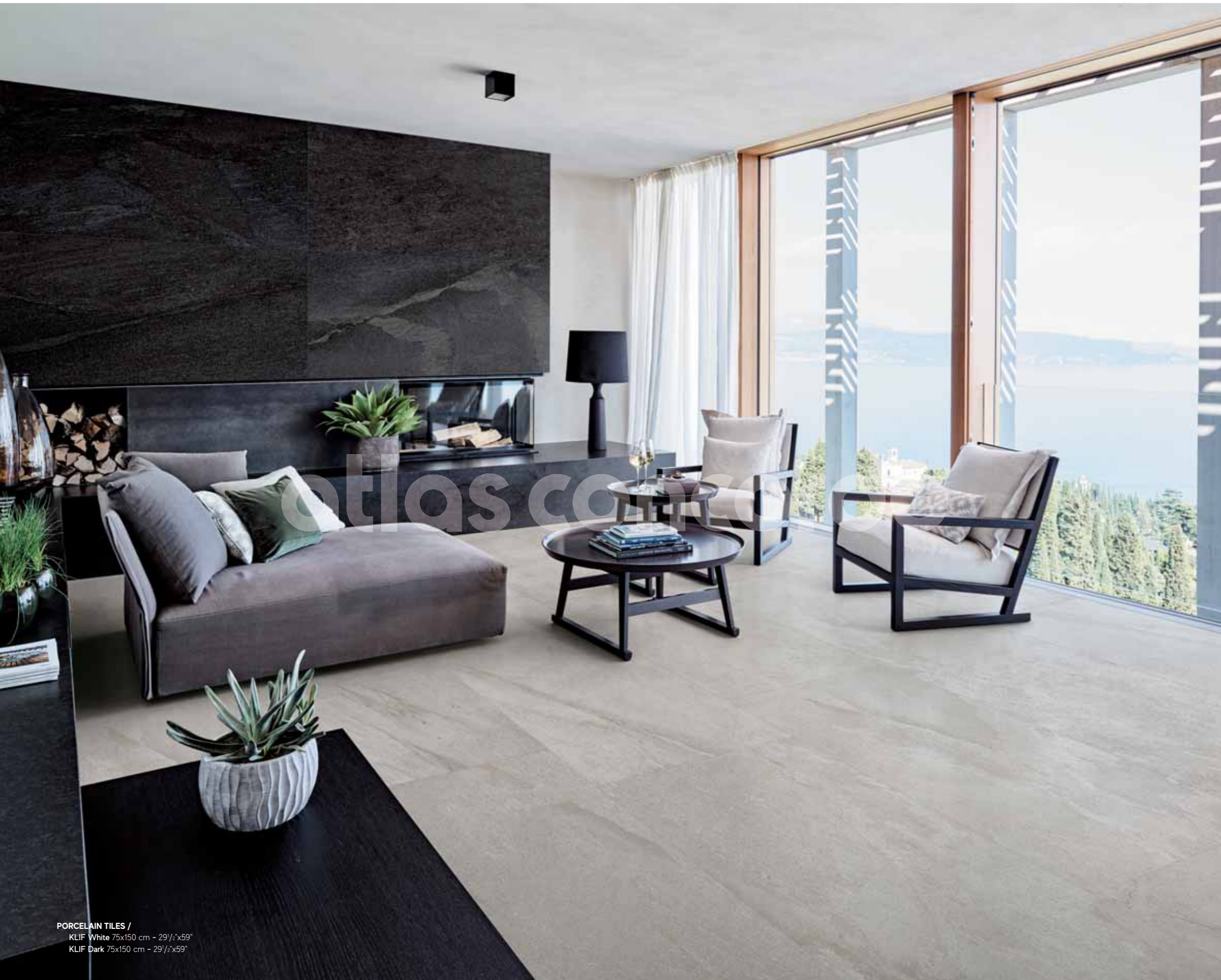

PORCELAIN TILES /
KLIF White 75x150 cm - 29 1/2"x59"
KLIF Dark 75x150 cm - 29 1/2"x59"



In a prestigious residential space surrounded by greenery, the look of stone is the ideal solution for bringing out the beauty of the material and underscoring the relationship with the external environment.

In un'architettura residenziale di pregio circondata dal verde, l'estetica della pietra si rivela la soluzione ideale per mettere in risalto la bellezza del materiale e valorizzare il rapporto con l'ambiente esterno.



FEELING / BALANCED



atlas concorde

The white-body wall tiles reveal the deep inspiration of natural stone without sacrificing the properties of ceramics, thus guaranteeing easy cleaning and removal of stains.

Il rivestimento in pasta bianca rivela la profonda ispirazione alla pietra naturale senza rinunciare alle proprietà della ceramica, che garantisce semplicità di pulizia e di rimozione delle macchie.

WALL TILES /
KLIF White 40x80 cm - 15 7/8" x 31 1/2"
KLIF 3D Row White 40x80 cm - 15 7/8" x 31 1/2"
KLIF White Corner 1,4x40 - 5 1/2" x 15 1/2"
KLIF 3D White Corner 1,4x40 - 5 1/2" x 15 1/2"
PORCELAIN TILES /
KLIF White 37,5x75 cm - 14 7/8" x 29 1/2"
KLIF Silver Triangles 28,5x33 cm - 11 1/4" x 13"
KLIF Silver Brick 37,5x75 cm - 14 7/8" x 29 1/2"
OUTDOOR PAVING
KLIF Silver 20mm 45x90 cm - 17 3/4" x 35 3/4"
ARBOR Natural 18,5x150 cm - 7 1/4" x 59"



atlas concorde

PRISTINE
ELEGANCE



THE ENERGY OF NATURE

—ES El revestimiento de pasta blanca interpreta fielmente la piedra natural fuente de inspiración, conservando las propiedades de la cerámica y garantiza simplicidad de limpieza y facilidad para eliminar las manchas.

—FR Le revêtement mural en pâte blanche s'inspire de la pierre naturelle sans renoncer aux propriétés de la céramique qui garantissent la simplicité de nettoyage et d'élimination des taches.

—DE Der weißscherbige Wandbelag besticht mit seiner überaus getreuen Natursteinoptik, die er mit den Vorzügen der Keramik vereint: Reinigung und Fleckenentfernung sind ein Kinderspiel.

—RU Настенная плитка из белой глины воссоздает фактуру камня без отказа от таких преимуществ керамики, как простота ухода и удаления пятен.



atlas concorde

KLIF
WALL TILES
3D ROW
WHITE

The sculptural three-dimensional ceramic wall reflects the beautiful look of the chiseled texture.

La scultorea parete ceramica tridimensionale riflette l'estetica eccelsa della texture a effetto scalpello.



PURE / WHITE

The coordinated White wall tiles ensure purity and stylistic continuity with the bathroom, enhancing the Silver color of the mosaic used in the shower floor.

Il rivestimento White coordinato garantisce purezza cromatica e continuità stilistica all'ambiente bagno, valorizzando il colore Silver del mosaico che disegna il tappeto della doccia.



atlas concorde

- Easy to clean micro-textured surface. Superficie micro-strutturata semplice da pulire.

atlas concorde

KLIF
WALL TILES
WHITE

The white-body wall tiles perfectly combine the functionality of ceramics with the original beauty of the stone effect.

Il rivestimento in pasta bianca coniuga alla perfezione la funzionalità della ceramica con la bellezza originaria dell'effetto pietra.





atlas concorde

- A high resistance to water and humidity makes porcelain tiles inert to the action of mold and fungi. L'alta resistenza all'acqua e all'umidità rende il gres porcellanato inerte all'azione di muffe e funghi.

FREEDOM *bf* EXPRESSION

A modern interpretation of cut decorations, the Triangles mosaic underscores the appeal of stone with its refined and balanced geometry.

Moderna interpretazione dei decori da taglio, il mosaico Triangles enfatizza il fascino della pietra con la sua geometria ricercata ed equilibrata.



atlas concorde



atlas concorde

The innate elegance of beola stone allows the design of environments characterized by pure and essential beauty, an expression of a strong and rigorous personality.

L'eleganza innata della beola permette di concepire ambienti caratterizzati da un'estetica pura ed essenziale, espressione di una personalità decisa e rigorosa.

PORCELAIN TILES /
KLIF Dark 75x150 cm - 29 1/2"x59"
KLIF Silver 75x150 cm - 29 1/2"x59"
KLIF Dark Brick 3D 28x55 cm - 11"x21 1/2"
KLIF Silver Brick 3D 28x55 cm - 11"x21 1/2"
ARBOR Cognac 18,5x150 cm - 7 1/4"x59"



atlas concorde

SURROUNDED
BY NATURE



SIMPLE SPIRIT

—ES Por la elegancia innata de la beola es posible crear ambientes caracterizados por una estética pura y esencial, expresión de una personalidad precisa y rigurosa.

—FR L'élégance innée de la beola permet de concevoir des espaces caractérisés par un esthétisme pur et minimaliste, une expression de grand caractère.

—DE Die dem Beola-Stein eigene Eleganz lässt Räume mit reiner und schlichter Ästhetik entstehen, als Ausdruck einer entschlossenen und konsequenten Persönlichkeit.

—RU Врожденная элегантность гнейса Beola дает возможность создавать лаконичные, строгие и в то же время яркие по характеру интерьеры.



- The surface guarantees high resistance to stains. La superficie garantisce un'elevata resistenza alle macchie.

The beauty of stone from Val d'Ossola returns to life in an extremely reliable and durable material that guarantees maximum resistance to stains and wear.

L'estetica della pietra della Val d'Ossola rivive in un materiale estremamente affidabile e duraturo, che garantisce la massima resistenza alle macchie e all'usura.



- Hygienic: does not absorb dirt and is easy to clean.
Igienico: non assorbe sporco ed è facile da pulire.



atlas concorde

● **Impact and wear resistant: suitable for commercial venues.**
Resistente agli urti e all'usura: è ideale in contesti commerciali.

A PERFECT SYNTHESIS



Combining the decisive appeal of stone with the characteristic reliability of porcelain tiles, Klif is the perfect synthesis of beauty and practicality.

atlas concorde

Coniugando il fascino deciso della pietra con l'affidabilità caratteristica del gres porcellanato, Klif si rivela la perfetta sintesi tra estetica e funzionalità.



atlas concorde

THE HARMONY / OF ELEGANCE

The look of beola stone from Val d'Ossola is reproduced with extreme realism in every detail.

L'estetica della beola, la pietra caratteristica della Val d'Ossola, è riprodotta con estremo realismo in ogni dettaglio.

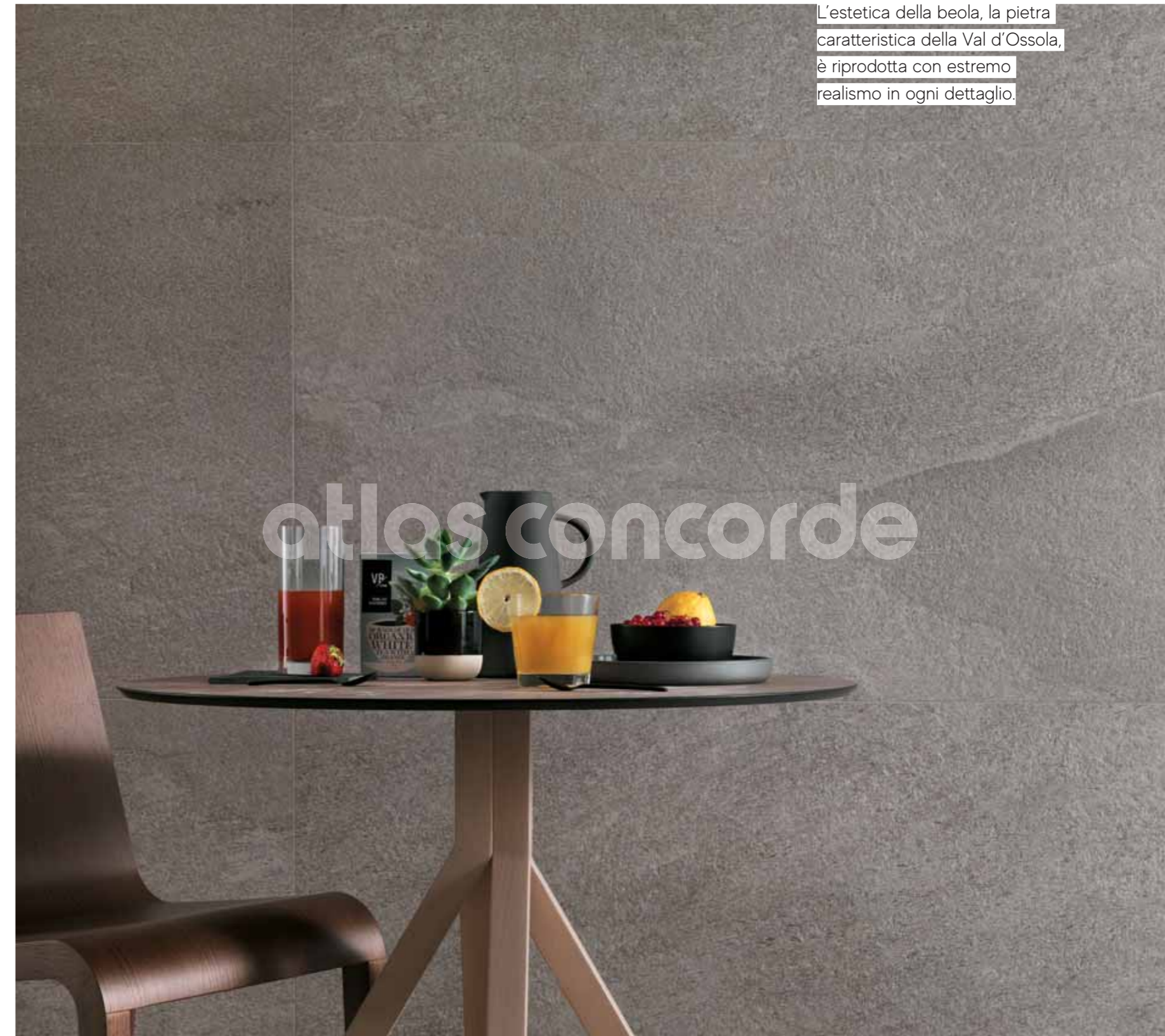



atlas concorde

Elegant stone-effect porcelain tile surfaces meet spectacular three-dimensional ceramic walls, whose refined sculptural impact is rich in light and shadows.

Eleganti superfici in gres porcellanato effetto pietra incontrano scenografiche pareti ceramiche tridimensionali, il cui raffinato impatto scultoreo è ricco di luci e ombre.



atlas concorde



atlas concorde



atlas concorde

KLIF
DARK

The earthy vigor of
the surface is softened
by the delicate movement
of the veins within.

La forza materica della
superficie è ammorbidita dal
movimento delicato
delle venature che la
disegnano.





atlasconcorde

The beauty of stone is rendered contemporary to become a refined floor and wall covering, capable of creating spaces that are both rigorous and enveloping.

L'estetica della pietra entra nella contemporaneità per diventare un rivestimento ricercato, capace di spazi rigorosi e al contempo avvolgenti.

WALL TILES /
KLIF 3D Row White 40x80 cm - 15 3/4" x 31 1/2"
PORCELAIN TILES /
KLIF Grey 75x150 cm - 29 1/2" x 59"
KLIF Grey 37,5x75 cm - 14 3/4" x 29 1/2"
KLIF White Brick 3D 28x55 cm - 11" x 21 1/2"
ARBOR Cognac 18,5x150 cm - 7 1/4" x 59"



atlasconcorde

NATURAL
WELCOME

TOUCHES **bf** COLOR

—ES La estética de la piedra natural entra en la época contemporánea para llegar a ser un revestimiento decorativo, creando espacios rigurosos y al mismo tiempo acogedores.

—DE Die Steinoptik hält Einzug in das moderne Innendesign und wird zum ausgesuchten Wandbelag, der Strenge und Behaglichkeit zugleich vermittelt.

—FR L'esthétisme de la pierre entre dans la contemporanéité pour devenir un revêtement raffiné, capable de créer des espaces à la fois rigoureux et enveloppants.

—RU Рисунок камня приобретает современное звучание, и превращается в изысканный декор строгих и, в то же время, пленительных интерьеров.



atlas concorde

- Does not contain hazardous substances and does not release volatile organic compounds (VOC).

Non contiene sostanze nocive, solventi e non rilascia composti organici volatili (VOC).



EXTREME / VERSATILITY

Four colors and seven formats - including the new 37.5x75 cm - offer a particularly versatile range that lends itself to numerous applications in residential and commercial settings.

Quattro cromie e sette formati, tra cui il nuovo 37,5x75, compongono una gamma particolarmente versatile, che si presta a numerose applicazioni in contesti residenziali e commerciali.





THE DIMENSION **OF** LIGHT

With its linear cut and the expressiveness of the chiseled texture, 3D Row gives the walls a contemporary look.

Con il suo andamento lineare e l'espressività della texture scalpellata, il rilievo 3D Row dona alle pareti un look contemporaneo.



WELCOME TO / THE ELEGANCE



atlas concorde



atlas concorde

The earthy aspect of stone creates an evocative environment in contemporary spaces, proving to be an appropriate choice even for reception areas.

L'aspetto materico della pietra arricchisce di suggestioni uno spazio dalle linee contemporanee, rivelandosi una scelta appropriata anche per gli ambienti destinati all'accoglienza.

KLIF PORCELAIN TILES

COLOURED BODY PORCELAIN TILES - RECTIFIED MONOCALIBER

GRES PORCELLANATO COLORATO IN MASSA - RETTIFICATO MONOCALIBRO

Gres porcelánico coloreado en masa - Rectificado monocalibre / Durchgefärbtes Feinsteinzeug - Geschliffen einkalibrig

Grès cérame coloré dans la masse - Rectifié mono-calibre / Керамический гранит окрашенный в массе - Ретифицированный в одном калибре

SIZES AND SURFACES / FORMATI E SUPERFICI

MATTE / MATT

MATE / MATT / MAT / МАТОВАЯ



75x150 cm - 29¹/₂"x59" ✂ 9,5 mm ♦

75x75 cm - 29¹/₂"x29¹/₂" ✂ 9,5 mm ♦

37,5x75 cm - 14³/₄"x29¹/₂" ✂ 9,5 mm ♦

GRIP / GRIP

GRIP / GRIP / GRIP / GRIP



37,5x75 cm - 14³/₄"x29¹/₂" ✂ 9,5 mm ♦

OUTDOOR PAVING / PAVIMENTI DA ESTERNO

PAVIMENTOS PARA EXTERIORES / BODENBELÄGE FÜR AUSSENBEREICHE

SOLS D'EXTÉRIEUR / УЛИЧНАЯ ПЛИТКА



90x90 cm - 35³/₈"x35³/₈" ✂ 20 mm *

45x90 cm - 17³/₄"x35³/₈" ✂ 20 mm *

60x60 cm - 23⁵/₈"x23⁵/₈" ✂ 20 mm *

♦ Available in all colors / Disponibile in tutti i colori

* Available in the following colors / Disponibile nei seguenti colori: Silver, Grey, Dark

PORCELAIN TILES ✂ 20 mm

For further details on the 20mm thick products, related trim pieces and installation systems - in particular for recommendations and precautions during installation- please refer to the Outdoor Design section on the Atlas Concorde website or to the Outdoor Design catalogue. Per dettagli sul prodotto e sui relativi pezzi speciali in 20mm di spessore, per i sistemi di posa e, in particolare, per raccomandazioni, accorgimenti e precauzioni in fase di posa e progettazione, si raccomanda di prendere visione del catalogo Outdoor Design e della sezione Outdoor Design del sito Atlas Concorde.

COLOR-SHADING STONALIZZAZIONE

White, Silver,
Grey, Dark



V3 MODERATE
VARIATION



KLIF PORCELAIN TILE DECORS

Klif White Mosaico
30x30 cm - 11³/₄"x11³/₄"

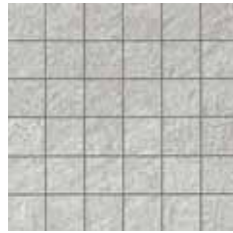

Klif Silver Mosaico
30x30 cm - 11³/₄"x11³/₄"



Klif Grey Mosaico
30x30 cm - 11³/₄"x11³/₄"

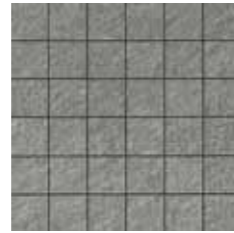

Klif Dark Mosaico
30x30 cm - 11³/₄"x11³/₄"

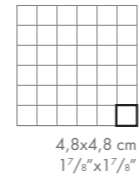

Klif White Triangles
28,5x33 cm - 11¹/₄"x13"



Klif Silver Triangles
28,5x33 cm - 11¹/₄"x13"



Klif Grey Triangles
28,5x33 cm - 11¹/₄"x13"

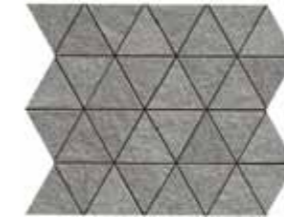

Klif Dark Triangles
28,5x33 cm - 11¹/₄"x13"

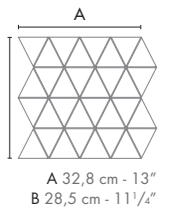

KLIF PORCELAIN TILE DECORS

Klif White Brick
37,5x75cm - 14³/₄"x29¹/₂"



Klif Silver Brick
37,5x75cm - 14³/₄"x29¹/₂"



Klif Grey Brick
37,5x75cm - 14³/₄"x29¹/₂"



Klif Dark Brick
37,5x75cm - 14³/₄"x29¹/₂"

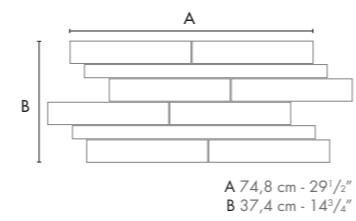

Klif White Brick 3D
28x55cm - 11"x21⁵/₈"

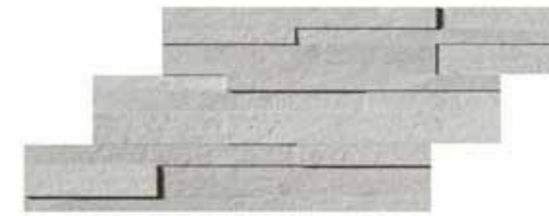

Klif Silver Brick 3D
28x55cm - 11"x21⁵/₈"

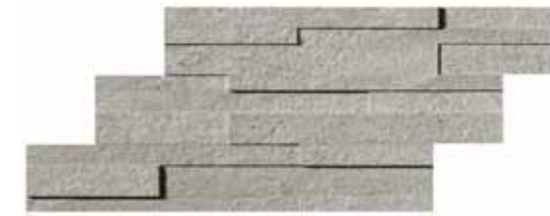

Klif Grey Brick 3D
28x55cm - 11"x21⁵/₈"

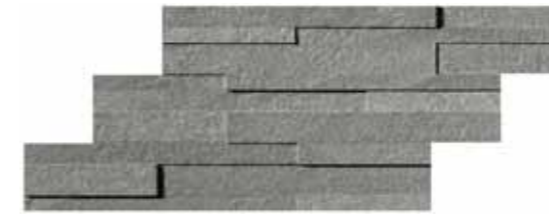

Klif Dark Brick 3D
28x55cm - 11"x21⁵/₈"

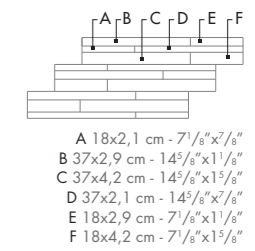

KLIF WALL TILES

40x80 cm - 15³/₄"x31¹/₂" ± 8,5 mm
3D Row 40x80 cm - 15³/₄"x31¹/₂" ± 10 mm



WHITEBODY WALL TILES - RECTIFIED MONOCALIBER

RIVESTIMENTI IN PASTA BIANCA - RETTIFICATO MONOCALIBRO

Revestimientos en pasta blanca - Rectificado monocalibre / Weißscherbige Wandfliesen - Geschliffen einkalibrig

Revêtements en pâte blanche - Rectifié mono-calibre / Настенная плитка из белой глины - Ретицированный в одном калибре

Klif White
40x80 cm - 15³/₄"x31¹/₂"



Klif 3D Row White
40x80 cm - 15³/₄"x31¹/₂"



Klif Silver
40x80 cm - 15³/₄"x31¹/₂"



Klif 3D Row Silver
40x80 cm - 15³/₄"x31¹/₂"



Klif Grey
40x80 cm - 15³/₄"x31¹/₂"



Klif 3D Row Grey
40x80 cm - 15³/₄"x31¹/₂"



COLOR-SHADING / STONALIZZAZIONE

White
Silver
Grey



V2 SLIGHT
VARIATION



atlas concorde

- Special elements such as corners and 3D corners allow the creation of stone-effect surfaces with total continuity, creating a result that has a strong realistic impact. Elementi speciali come corner 3D e angoli permettono di realizzare superfici a effetto pietra in totale continuità, con un risultato dal forte impatto realistico.

KLIF PORCELAIN TRIM TILES

INDOOR TRIM TILES

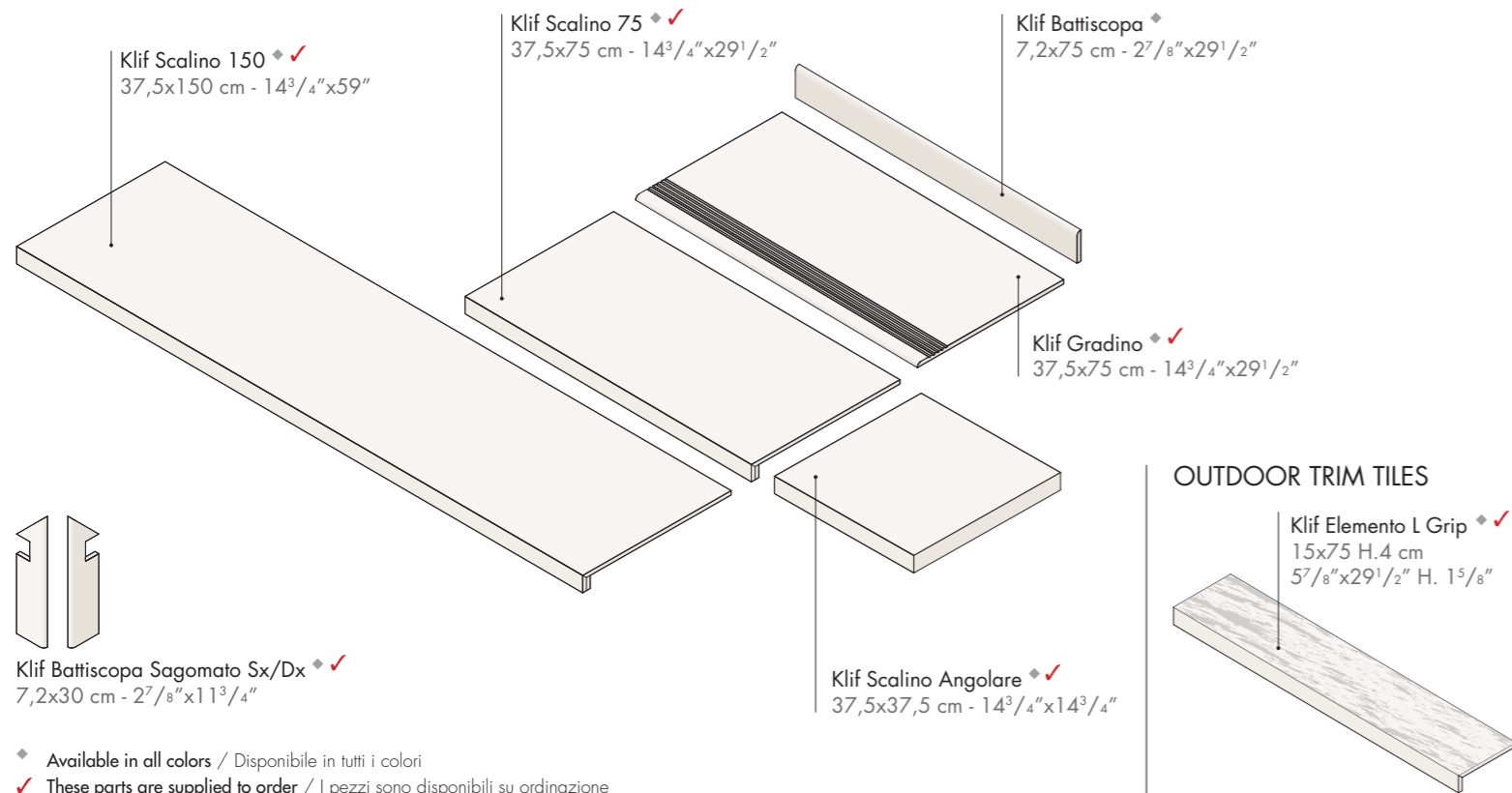

OUTDOOR TRIM TILES

OUTDOOR TRIM TILES ± 20 mm

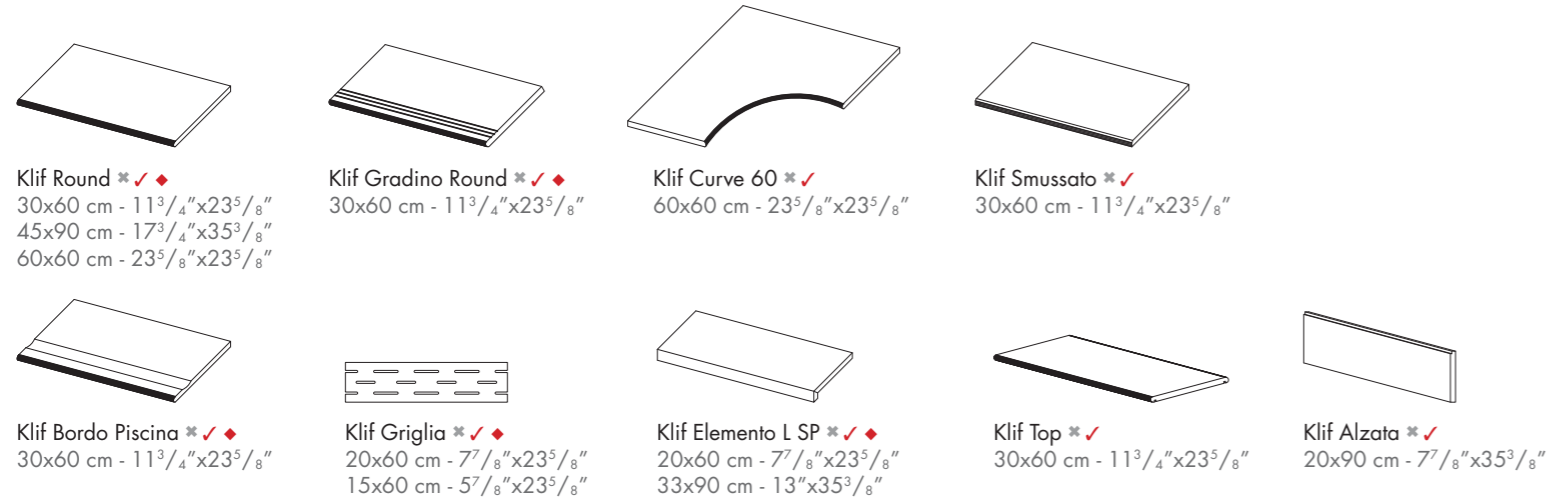

♦ Right/left angular elements are available / Sono disponibili gli elementi angolari dx/sx
* Available in the following colors / Disponibile nei seguenti colori: Silver, Grey, Dark

WALL TRIM TILES

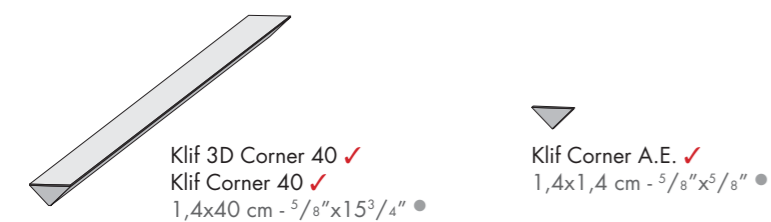

● Available in the following colors
Disponibile nei seguenti colori: White, Silver, Grey
✓ These parts are supplied to order
I pezzi sono disponibili su ordinazione



NOTES

For information and details relating to codes, packaging and weight it is recommended to refer to the latest pricelist. | Per le informazioni e i dati relativi a codici, imballaggi e pesi occorre sempre consultare l'ultimo listino aggiornato e in vigore. | Para acceder a la información y a los datos relativos a códigos, embalajes y pesos hay que consultar siempre la última lista de precios actualizada y vigente. | Für Informationen und Daten die den Code, die Verpackung und das Gewicht betreffen bitte die aktuellste Preisliste zugrunde legen. | Pour toutes informations et renseignements concernant les codes, les emballages et les poids, il y a toujours lieu de consulter le dernier tarif en vigueur et mis à jour. | Для информации о кодах, упаковках и весе обращайтесь к последнему действующему прайс-листу.

Colors and optical features of the materials illustrated in this catalogue are to be regarded as mere indications. | I colori e le caratteristiche estetiche dei materiali illustrati nel presente catalogo sono da ritenersi puramente indicativi. | Los colores y las características estéticas de los materiales ilustrados en el presente catálogo deben ser considerados como puramente indicativos. | Die Farben und die ästhetischen Eigenschaften der in diesem Katalog abgebildeten Produkte sind als reine Richtwerte zu betrachten. | Les coloris et les caractéristiques esthétiques des références illustrées dans le catalogue sont donnés à titre purement indicatif. | Цвета и эстетические характеристики описанных в настоящем каталоге материалов являются только ориентировочными.

Atlas Concorde reserves the right to modify any product without notice and will not be liable for any direct or indirect damage resulting from such modifications. | Atlas Concorde si riserva di modificare i prodotti senza preavviso, declinando ogni responsabilità su eventuali danni diretti o indiretti derivanti da eventuali modifiche. | Atlas Concorde se reserva el derecho de modificar los productos sin previo aviso, rechaza cualquier responsabilidad sobre eventuales daños directos o indirectos derivados de eventuales modificaciones. | Atlas Concorde behält sich das Recht vor jederzeit und ohne vorherige Ankündigung, die Produkte zu verändern, und lehnt jede Haftung bei direkten oder indirekten Schäden ab, die von diesen Veränderungen herrühren. | Atlas Concorde se réserve le droit de modifier ses produits sans préavis et décline toute responsabilité concernant les éventuels dommages directs ou indirects qui pourraient dériver de ces modifications. | Atlas Concorde оставляет за собой право изменять характеристики изделий без предварительного уведомления, отклоняя при этом любую ответственность за прямые или косвенные убытки, возникшие в результате изменений.

THANKS TO

cielo
handmade in Italy
www.ceramicacielo.it

PRANDINA
www.prandina.it

Billiani
1911
www.billiani.it

NEVE
www.neve-rubinetterie.it

ALICE
CERAMICA
www.aliceceramica.com

Frag
dal 1921
www.frag.it

ICONE
www.iconeluce.com



White Body wall tiles - Rectified monocaliber

Compliant with standards EN 14411 annex L group BIII
Compliant with standards ISO 13006 annex L group BIII
Conforme alla norma EN 14411 Appendice L gruppo BIII
Conforme alla norma ISO 13006 Appendice L gruppo BIII

Rivestimenti in pasta bianca - Rettificato monocalibro

40x80 cm - 15³/₄"x31¹/₂" \pm 8,5 mm
40x80 cm - 15³/₄"x31¹/₂" \pm 10 mm 3D Row

Table with technical specifications for White Body wall tiles, including test methods (ISO 10545-2, EN 1348, etc.) and requirements for nominal size N.

Table with technical specifications for Klif Wall Tiles, including breaking strength (S ≥ 600 N), modulus of rupture (R ≥ 15 N/mm²), and resistance to fire (Class A1).

Coloured body porcelain tiles - Rectified monocaliber



Compliant with standards EN 14411 annex G group BIa
Compliant with standards ISO 13006 annex G group BIa
Conforme alla norma EN 14411 Appendice G gruppo BIa
Conforme alla norma ISO 13006 Appendice G gruppo BIa

Gres porcellanato colorato in massa - Rettificato monocalibro

75x150 cm - 29¹/₂"x59" \pm 9,5 mm
75x75 cm - 29¹/₂"x29¹/₂" \pm 9,5 mm
37,5x75 cm - 14³/₈"x29¹/₂" \pm 9,5 mm
90x90 cm - 35³/₈"x35³/₈" \pm 20 mm
45x90 cm - 17³/₈"x35³/₈" \pm 20 mm
60x60 cm - 23³/₈"x23³/₈" \pm 20 mm

Table with technical specifications for Coloured body porcelain tiles, including test methods (ISO 10545-2, EN 1339, etc.) and requirements for nominal size N.

Table with technical specifications for Klif Porcelain Tiles, including breaking strength (S ≥ 1500 N) and resistance to fire (Class A1).

^(*) The permissible deviation, in % or mm, of the average size for each tile (2 or 4 sides) from work size (WS).
^(**) The permissible deviation, in % or mm, of the average thickness for each tile from the work size thickness (WS).
^(***n) The maximum permissible deviation from straightness, in % or mm, related to the corresponding work sizes (WS).
^(****) The maximum permissible deviation from center curvature, in % or mm, related to the corresponding work sizes (WS).
c.c. The maximum permissible deviation from center curvature, in % or mm, related to the corresponding work sizes (WS).
e.c. The maximum permissible deviation from edge curvature, in % or mm, related to the corresponding work sizes (WS).
w. The maximum permissible deviation from warpage, in % or mm, related to diagonal calculated from the work sizes (WS).

^(*) The permissible deviation, in % or mm, of the average size for each tile (2 or 4 sides) from work size (WS).
^(**) The permissible deviation, in % or mm, of the average thickness for each tile from the work size thickness (WS).
^(***n) The maximum permissible deviation from straightness, in % or mm, related to the corresponding work sizes (WS).
^(****) The maximum permissible deviation from center curvature, in % or mm, related to the corresponding work sizes (WS).
c.c. The maximum permissible deviation from center curvature, in % or mm, related to the corresponding work sizes (WS).
e.c. The maximum permissible deviation from edge curvature, in % or mm, related to the corresponding work sizes (WS).
w. The maximum permissible deviation from warpage, in % or mm, related to diagonal calculated from the work sizes (WS).
⁽¹⁾ Determination of slip resistance of pedestrian surfaces; it does not cover sports surfaces and road surfaces for vehicles (skid resistance).
⁽²⁾ Anti-slip performance is guaranteed at the time of delivery of the product.
⁽³⁾ However, tiles with a DCOF of 0.42 or greater are not necessarily suitable for all projects.
⁽⁴⁾ For further details, please refer to outdoor design general catalogue.
⁽⁵⁾ Only for products with 20 mm thickness.
⁽⁶⁾ PTV ≥ 36 Wet on demand / su richiesta
⁽⁷⁾ P3 on demand / su richiesta
⁽⁸⁾ C2 on demand / su richiesta



SUSTAINABILITY

In the environmental and economic sciences, sustainability is defined as the condition of development capable of ensuring the satisfaction of the needs of the present generation without compromising the ability of future generations to realize their own. Several international certifications guarantee that the Atlas Concorde products meet the criteria of sustainable construction, attesting to their low impact on the ecosystem, compliance with declared standards and attention to comfort.

SOSTENIBILITÀ

Nelle scienze ambientali ed economiche, la sostenibilità è definita come condizione di uno sviluppo in grado di assicurare il soddisfacimento dei bisogni della generazione presente senza compromettere la possibilità delle generazioni future di realizzare i propri. Diverse certificazioni internazionali garantiscono che i prodotti Atlas Concorde rispondono ai criteri del costruire sostenibile, attestandone il basso impatto sull'ecosistema, la conformità agli standard dichiarati e l'attenzione al comfort abitativo.

CERTIFICATIONS

In 1995 Atlas Concorde obtained **ISO 9001** quality certification for its products. It is an international recognition referring to the company's entire quality system, from the receipt of raw materials to their transformation, from the distribution of the product to their placement on the market. The environmental footprint of products (**PEF, Product Environmental Footprint**, according to Recommendation 2013/179/EU) is a measurement that, based on various criteria, indicates the environmental performance of a product or service over its lifetime, taking into account supply chain activities: from the extraction of raw materials, to the production, use, and end of life of the product. Atlas Concorde has a certified PEF. Atlas Concorde's PEF was verified by the DNV-GL certifying body. Atlas Concorde also has an EPD declaration, which attests to the environmental sustainability of its products. The **EPD (Environmental Product Declaration)** also assesses the life cycle of a product, from extraction to the factory gate, before it is transported and distributed for sale. Atlas Concorde's EPD declaration was certified by the independent certifying body EPD ITALY. Atlas Concorde has a **HPD (Health Product Declaration)** declaration, a complete report on the health characteristics of the finished product, compiled according to the HPD standard. Atlas Concorde has also drafted an FDES environmental declaration (Fiche de déclaration environnementale et sanitaire), this also having the purpose of transparently disclosing the product's impact, covering each phase from product extraction to production and finally laying and use.

CERTIFICAZIONI

Sin dal 1995 Atlas Concorde ha ottenuto per i propri prodotti la certificazione di qualità **ISO 9001**. Si tratta di un riconoscimento internazionale riferito all'intero sistema di qualità aziendale, dall'ingresso delle materie prime alla loro trasformazione, dalla distribuzione del prodotto alla sua immissione sul mercato. L'impronta ambientale dei prodotti (**PEF, Product Environmental Footprint**, secondo la Raccomandazione 2013/179/UE) è una misura che, sulla base di vari criteri, indica le prestazioni ambientali di un prodotto o servizio nel corso del proprio ciclo di vita, tenendo conto delle attività della catena di approvvigionamento: dall'estrazione di materie prime, alla produzione, all'uso e fine vita del prodotto. Atlas Concorde dispone di una PEF certificata. La PEF di Atlas Concorde è verificata dall'organismo di certificazione DNV-GL. Atlas Concorde dispone inoltre di una dichiarazione EPD, che attesta la sostenibilità ambientale dei prodotti. Anche la **EPD (Environmental Product Declaration)** valuta il ciclo di vita di un prodotto, dall'estrazione al cancello della fabbrica, prima che sia trasportato e distribuito per la vendita. La dichiarazione EPD di Atlas Concorde è stata certificata dall'ente di certificazione indipendente EPD ITALY. Atlas Concorde dispone della dichiarazione **HPD (Health Product Declaration)**, un report completo sulle caratteristiche di salubrità del prodotto finito, compilato secondo lo standard HPD. Atlas Concorde ha realizzato inoltre la dichiarazione ambientale FDES (Fiche de déclaration environnementale et sanitaire), anch'essa con lo scopo di rendicontare in modo trasparente l'impatto del prodotto, a partire dalla fase di estrazione del prodotto, passando dalla fase di produzione, fino alla posa ed all'utilizzo.

LEED V4

All Atlas Concorde porcelain floor and white body wall tiles can be used in projects that follow the guidelines of the **GREEN BUILDING COUNCIL**, which promotes the independent certification system **LEED BD&C v4** (Leadership in Energy and Environmental Design, Building Design & Construction), whose parameters establish precise criteria for the design and construction of buildings that are healthy, energy efficient and with low environmental impact. Ceramiche Atlas Concorde is a member of the US Green Building Council. All our products in porcelain stoneware and in white clay can therefore contribute to obtaining the LEED V4 rating of buildings, in relation to different areas: Sustainability of the Site, Materials and Resources, Internal Environmental Quality.

LEED V4

Tutti i prodotti in gres porcellanato e in pasta bianca Atlas Concorde possono essere utilizzati in progetti che seguono le linee guida del **GREEN BUILDING COUNCIL**, che promuove il sistema di certificazione indipendente **LEED BD&C v4** (Leadership in Energy and Environmental Design, Building Design & Construction), i cui parametri stabiliscono precisi criteri di progettazione e realizzazione di edifici salubri, energeticamente efficienti e a impatto ambientale contenuto. Ceramiche Atlas Concorde è membro dell'US Green Building Council. Tutti i nostri prodotti in gres porcellanato e in pasta bianca possono quindi contribuire all'ottenimento del rating LEED V4 degli edifici, relativamente a diverse aree tematiche: Sostenibilità del Sito, Materiali e Risorse, Qualità ambientale Interna.



MADE IN ITALY

The Made in Italy logo of Atlas Concorde stands for style, quality and ethics. Having firmly adhered to the Ethical Code promoted by Confindustria Ceramica, Atlas Concorde places the Made in Italy logo on all the products designed and produced in Italy, that is to say ceramic tiles, decorations and the majority of special trim tiles. Only a small amount of the latter is manufactured in Spain. Atlas Concorde products are produced using eco-friendly technologies, top quality and safe raw materials with the best working conditions guaranteed for our personnel. For these reasons, Atlas Concorde's Made in Italy is the expression of strong values such as style, design, product quality, and respect for the environment and the people who live in it.

Il marchio *Made in Italy* di Atlas Concorde è sinonimo di stile, qualità ed etica. Avendo aderito con convinzione al Codice Etico di Confindustria Ceramica, Atlas Concorde appone il marchio *Made in Italy* su tutti i prodotti studiati, progettati e realizzati in Italia, nella fattispecie tutte le piastrelle di ceramica, le decorazioni e la maggioranza dei pezzi speciali. Solo un ristretto numero di questi ultimi è fabbricato in Spagna. I prodotti Atlas Concorde sono inoltre realizzati con tecnologie rispettose dell'ambiente, utilizzando materie prime eccellenti e sicure, garantendo le migliori condizioni di lavoro. Per queste ragioni il *Made in Italy* di Atlas Concorde è espressione di valori forti quali stile, design, qualità del prodotto, attenzione all'ambiente e alle persone.



The Ceramics of Italy logo is an exclusive identification on ceramic products which have effectively been made in Italy by companies that are a part of the Confindustria Ceramica and who adhered to its Ethical Code. This Code, promoted and created by Confindustria Ceramica, commits all companies to communicate, clearly and with transparency, the origin of their products.

Il marchio *Ceramics of Italy* contrassegna esclusivamente i prodotti ceramici effettivamente realizzati in Italia da un'azienda associata a Confindustria Ceramica che ha sottoscritto il Codice Etico. Il Codice, redatto dalla stessa Confindustria Ceramica, impegna a comunicare con chiarezza l'origine dei prodotti.

www.ceramica.info



MADE IN ITALY. MADE TO EXCEL.

CERAMICHE ATLAS CONCORDE S.p.A.
Via Canaletto 141
41042 Spezzano di Fiorano (MO) – Italia

ATLAS CONCORDE USA, Inc.
117 Seaboard Lane - Suite 170
Franklin, TN 37067 - USA

ATLAS CONCORDE RUSSIA
Business centre "Meliora Place"
Prospekt Mira 6, 129090 Moscow – Russia

www.atlasconcorde.com

Copyright 2018 by Ceramiche Atlas Concorde S.p.A.
(Spezzano di Fiorano, MO - Italy)
Tipolitografia Pagani
September 2018

